

# Contents

<b>1</b>	<b>Instructions</b>	<b>4</b>
1.1	General safety instructions	4
1.2	Manufacturer liability	5
1.3	Appliance purpose	5
1.4	Disposal	5
1.5	Identification plate	6
1.6	This user manual	6
1.7	How to read the user manual	6
<b>2</b>	<b>Description</b>	<b>7</b>
2.1	General Description	7
2.2	Control panel	7
2.3	Other parts	8
2.4	Available accessories	9
<b>3</b>	<b>Use</b>	<b>10</b>
3.1	Instructions	10
3.2	First use	10
3.3	Using the accessories	11
3.4	Using the auxiliary oven	11
3.5	Using the main oven with display	12
3.6	Cooking advice	16
3.7	Special functions	20
3.8	Preset programs	28
3.9	Personal recipes	36
3.10	Settings	40
<b>4</b>	<b>Cleaning and maintenance</b>	<b>44</b>
4.1	Instructions	44
4.2	Cleaning the surfaces	44
4.3	Ordinary daily cleaning	44
4.4	Food stains or residues	44
4.5	Removing the door	44
4.6	Cleaning the door glazing	45
4.7	Removing the internal glass panels	45
4.8	Cleaning the inside of the oven	46
4.9	Pyrolytic (main oven only)	47
4.10	Extraordinary maintenance	49
<b>5</b>	<b>Installation</b>	<b>51</b>
5.1	Electrical connection	51
5.2	Cable replacement	52
5.3	Positioning	52

We advise you to read this manual carefully, which contains all the instructions for maintaining the appliance's aesthetic and functional qualities.

For further information on the product: [www.smeg.com](http://www.smeg.com)



# Instructions

## 1 Instructions

### 1.1 General safety instructions

#### Risk of personal injury

- During use the appliance and its accessible parts become very hot.
- Never touch the heating elements during use.
- Keep children under eight years of age at a safe distance if they are not constantly supervised.
- Children must never play with the appliance.
- Never rest metallic objects such as knives, forks, spoons and lids on the appliance during use.
- Switch the appliance off immediately after use.
- Never try to put out a fire or flames with water: turn off the appliance and smother the flames with a fire blanket or other appropriate cover.
- The appliance must never be cleaned by unsupervised children.
- Have qualified personnel carry out installation and assistance interventions according to the standards in force.
- Do not modify this appliance.
- Do not insert pointed metal objects (cutlery or utensils) into the slots in the appliance.

- Do not try to repair the appliance yourself or without the intervention of a qualified technician.
- If the power supply cable is damaged, contact technical support immediately and they will replace it.

#### Risk of damaging the appliance

- Do not use abrasive or corrosive detergents on glass parts (e.g. powder products, stain removers and metallic sponges).
- Use wooden or plastic utensils.
- Do not seat on the appliance.
- Do not use steam jets to clean the appliance.
- Do not obstruct ventilation openings and heat dispersal slots.
- Never leave the appliance unattended during cooking operations where fats or oils could be released.
- Never leave objects on the cooking surface.
- Do not use the appliance to heat rooms for any reason.



## For this appliance

- Ensure that the appliance is switched off before replacing the bulb.
- Do not rest any weight or sit on the open door of the appliance.
- Take care that no objects are stuck in the doors.

## 1.2 Manufacturer liability

The manufacturer declines all liability for damage to persons or property caused by:

- use of the appliance other than the one envisaged;
- non-observance of the user manual provisions;
- tampering with any part of the appliance;
- use of non-original spare parts.

## 1.3 Appliance purpose

- This appliance is intended for cooking food in the home environment. Every other use is considered improper.
- This appliance may be used by children aged at least 8 and by people of reduced physical and mental capacity, or lacking in experience in the use of electrical appliances, unless they are supervised or instructed by adults who are responsible for their safety.
- The appliance is not designed to operate with external timers or with remote-control systems.

## 1.4 Disposal



This appliance must be disposed of separately from other waste (Directives 2002/95/EC, 2002/96/EC, 2003/108/EC). The appliance does not contain substances in quantities sufficient to be considered hazardous to health and the environment, in accordance with current European directives.

To dispose of the appliance:

- Cut the power supply cable and remove it along with the plug.



**Power voltage**

**Danger of electrocution**

- Disconnect the main power supply.
- Unplug the power cable from the socket.
- Deliver the appliance to the appropriate recycling facility for electrical and electronic equipment waste, or deliver it back to the retailer when purchasing an equivalent product, on a one for one basis.



# Instructions

Our appliances are packed in non-polluting and recyclable materials.

- Deliver the packing materials to the appropriate recycling facility.



## Plastic packaging Danger of suffocation

- Do not leave the packaging or any part of it unattended.
- Do not let children play with the packaging plastic bags.

## 1.5 Identification plate

The identification plate bears the technical data, serial number and brand name of the appliance. Do not remove the identification plate for any reason.

## 1.6 This user manual

This user manual is an integral part of the appliance and must therefore be kept in its entirety and in an accessible place for the whole working life of the appliance.

Read this user manual carefully before using the appliance.

## 1.7 How to read the user manual

This user manual uses the following reading conventions:

### Instructions



General information on this user manual, on safety and final disposal.

### Description



Description of the appliance and its accessories.

### Use



Information on the use of the appliance and its accessories, cooking advice.

### Cleaning and maintenance



Information for proper cleaning and maintenance of the appliance.

### Installation



Information for the authorised persons: installation, operation and inspection.



Safety instructions



Information



Advice

1. Use instruction sequence.

- Stand-alone use instruction.



## 2 Description

### 2.1 General Description

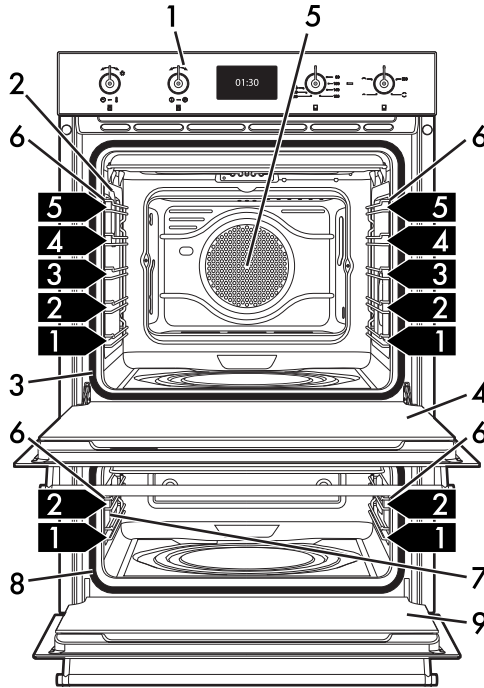

- 1 Control panel
- 2 Main oven light
- 3 Main oven seal
- 4 Main oven door
- 5 Fan

6 Rack/tray support frames

**1,2,3** Frame shelf

7 Auxiliary oven light

8 Auxiliary oven seal

9 Auxiliary oven door

### 2.2 Control panel

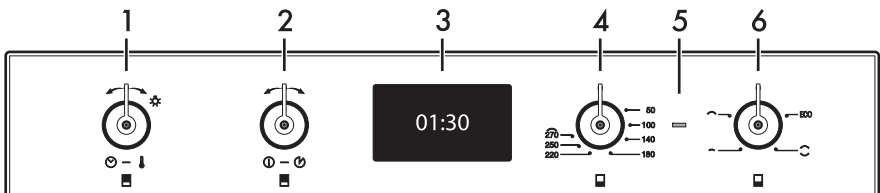



# Description

## 1 Main oven temperature knob

This knob allows you to select the cooking time and temperature, set programmed cooking and the current time as well as turn the light inside the oven on and off.

## 2 Main oven function knob

This knob allows you to turn the appliance on and off and select the cooking function.

## 3 Main oven display

Displays the current time, the selected cooking temperature and function and any time set.

## 4 Auxiliary oven temperature knob

This knob allows you to select the cooking temperature.

Turn the knob clockwise to the required value, between the minimum and maximum settings.

## 5 Auxiliary oven thermostat indicator light

The thermostat indicator light remains lit when the oven is heating up. Once the oven has reached the selected temperature the indicator light switches off.

## 6 Auxiliary oven function knob

The oven's various functions are suitable for different cooking modes. After selecting the required function, set the cooking temperature using the temperature knob.

## 2.3 Other parts

### Shelves

The appliance features shelves for positioning trays and racks at different heights. The insertion heights are indicated from the bottom upwards (see 2.1 General Description).

### Cooling fan

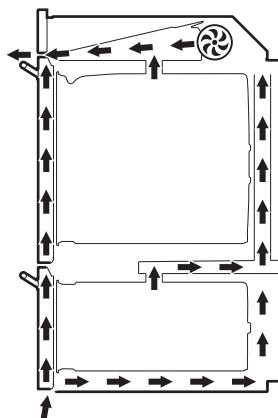

The fan cools the oven and comes into operation during cooking.

The fan causes a steady outflow of air from above the door which may continue for a brief period of time even after the appliance has been turned off.

### Interior lighting

The appliance interior lighting comes on:

- when the door is opened;
- when any function is selected, except for **ECO P** and **P**;
- by turning the temperature knob right when no function is selected (turn the temperature knob right again to switch off interior lighting).



## 2.4 Available accessories

**i** Some models are not provided with all accessories.

### Rack

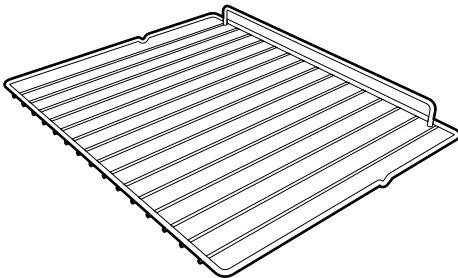
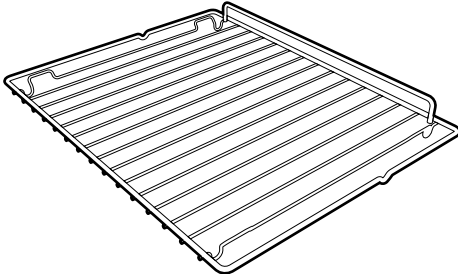

Useful for supporting containers with food during cooking.

### Tray rack

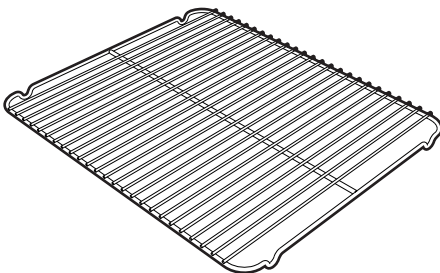

To be placed over the top of the oven tray; for cooking foods which may drip.

### Oven tray

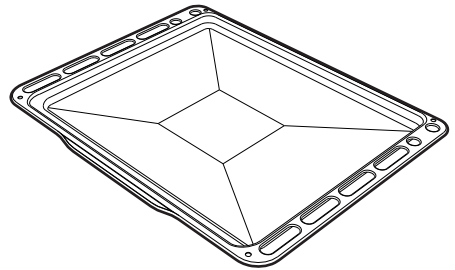

Useful for collecting fat from foods placed on the rack above and for cooking sweets, biscuits, etc.

### Deep tray

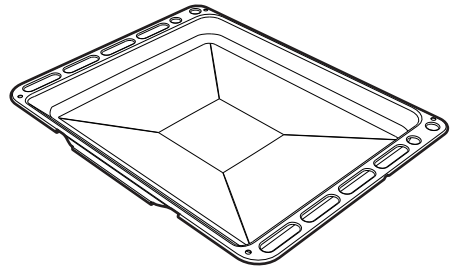

Useful for collecting fat from foods placed on the rack above and for cooking sweets, biscuits, etc.

**i** The oven accessories intended to come into contact with food are made of materials that comply with the provisions of current legislation.

**i** Original supplied and optional accessories can be requested to Authorised Assistance Centres. Use only original accessories supplied by the manufacturer.



## 3 Use

### 3.1 Instructions



**High temperature inside the oven during use**

**Danger of burns**

- Keep the oven door closed during cooking.
- Protect your hands wearing heat resistant gloves when moving food inside the oven.
- Do not touch the heating elements inside the oven.
- Do not pour water directly onto very hot trays.
- Do not allow children to get near the oven when it is in operation.



**High temperature inside the oven during use**

**Danger of fire or explosion**

- Do not spray any spray products near the oven.
- Do not use or leave flammable materials near the oven.
- Do not use plastic kitchenware or containers when cooking food.
- Do not put sealed tins or containers in the oven.
- Do not leave the oven unattended during cooking operations where fats or oils could be released.
- Remove all trays and racks which are not required during cooking.



**Improper use**

**Risk of damage to enamelled surfaces**

- Do not cover the bottom of the oven cavity with aluminium or tin foil sheets.
- If you wish to use greaseproof paper, place it so that it will not interfere with the hot air circulation inside the oven.
- Do not place pans or trays directly on the bottom of the oven cavity.
- Do not pour water directly onto very hot trays.

### 3.2 First use

1. Remove any protective film from the outside or inside of the appliance, including accessories.
2. Remove any labels (apart from the technical data plate) from the accessories and from the oven cavity.
3. Remove and wash all the appliance accessories (see 4 Cleaning and maintenance).
4. Heat the empty oven at the maximum temperature to burn off any residues left by the manufacturing process.





### 3.3 Using the accessories

#### Racks and trays

Racks and trays have to be inserted into the side guides until they come to a complete stop.

- The mechanical safety locks that prevent the rack from being taken out accidentally have to face downwards and towards the oven back.

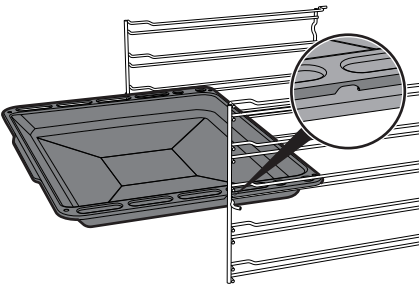
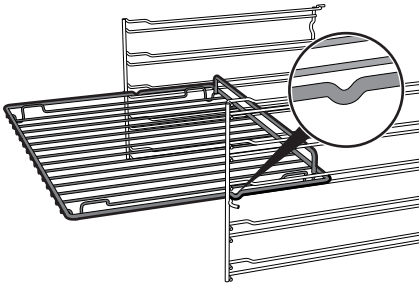

Gently insert racks and trays into the oven until they come to a stop.



Clean the trays before using them for the first time to remove any residues left by the manufacturing process.

#### Tray rack

The tray rack has to be inserted into the tray. In this way fat can be collected separately from the food which is being cooked.

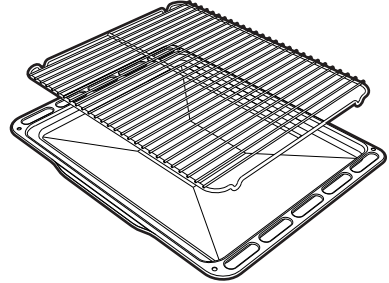

### 3.4 Using the auxiliary oven



The two ovens can be used at the same time, except for the Pyrolytic function.

To switch the auxiliary oven on:

- Select the cooking function using the function knob.
- Select the temperature using the temperature knob.



## 3.5 Using the main oven with display



The display only refers to the main oven. It has no control of the auxiliary oven.

### First use

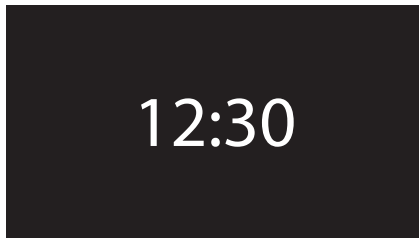

On the first use, or after a power failure, **00:00** will be flashing on the appliance's display. In order to be able to start any cooking program, the current time must be set (if the oven is being turned on for the first time, it is also recommended you set the required language).

Press the control knob to enter the settings menu, see "3.10 Settings".



The appliance language is set to "English" by default.



When first connecting or after the power has been cut for a time it will be necessary to wait a few seconds before you can interact with the appliance.

### Favourites

Press the return knob from the clock screen to display the last preset programs or personal recipes used.

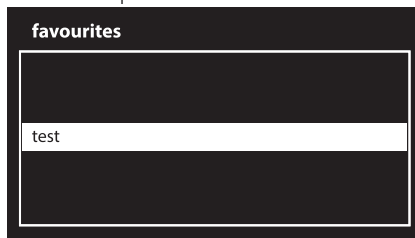

### Deleting favourites

If you wish to delete the favourites:

1. Press the return knob from the clock screen to display the last preset programs or personal recipes used.
2. Hold the control knob down for a few seconds.



3. Select **YES** if you wish to delete the favourites.

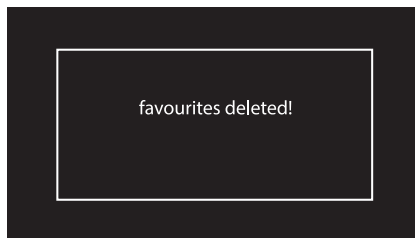



## Cooking functions

1. Turn the control knob to the right or left to select **cooking functions** from the main menu. Then press it to confirm.

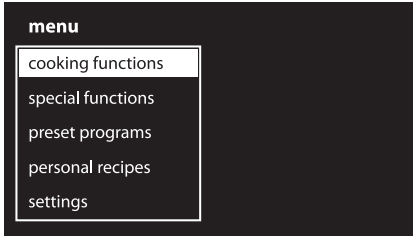

2. Turn the control knob to select the required function. Press the knob to confirm the selection.

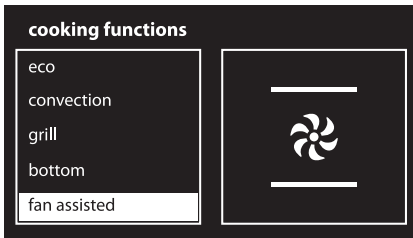

3. The appliance will begin automatic preheating. The display will show the chosen function, the pre-set temperature, the current time and the progress bar of the temperature reached (preheating).

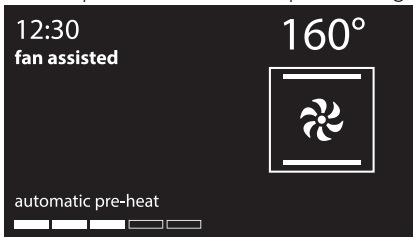

Turn the control knob to change the preset temperature at any time. Press to confirm or wait 5 seconds.



It is not recommended to place the dish in the oven during the automatic pre-heat stage.

4. When the preheating stage is over a buzzer will sound to indicate that the food can be placed inside the oven.



## Interrupting a function

Press the return knob to interrupt a cooking function. Select the required option and confirm it using the return knob.

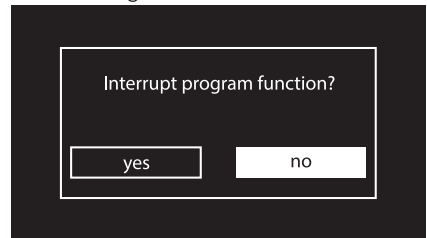

Keep the control knob pressed in for at least 5 seconds to immediately interrupt cooking at any time and return to the main menu.



## List of cooking functions



Certain functions are not available on all models.

**ECO**

### Eco

The combination of the fan and the circular heating element, in ECO mode, is particularly indicated for cooking on a single shelf, with reduced power consumption.

**ECO**



### Convection

As the heat comes from above and below at the same time, this system is particularly suitable for certain types of food. Traditional cooking, also known as static cooking, is suitable for cooking just one dish at a time. Perfect for all types of roasts, bread and cakes and in any case particularly suitable for fatty meats such as goose and duck.



### Grill

The heat coming from the grill element gives perfect grilling results above all for thin and medium thickness meat and in combination with the rotisserie (where fitted) gives the food an even browning at the end of cooking. Perfect for sausages, ribs and bacon. This function enables large quantities of food, particularly meat, to be grilled evenly.



### Bottom

The heat coming just from the bottom allows you to complete the cooking of foods that require a higher bottom temperature, without affecting their browning. Perfect for cakes, pies, tarts and pizzas.



### Fan assisted

The operation of the fan, combined with traditional cooking, ensures consistent cooking even with complex recipes. Perfect for biscuits and cakes, even when cooked simultaneously on several levels. (For multiple-level cooking, we recommend using the 1<sup>st</sup> and 4<sup>th</sup> shelves.)



### Fan grill

The air produced by the fan softens the strong heatwave generated by the grill, grilling perfectly even very thick foods. Perfect for large cuts of meat (e.g. shin of pork).



### Baker's function

The combination of the fan with just the lower heating element allows cooking to be completed more rapidly. This system is recommended for sterilising or for finishing off the cooking of foods which are already well-cooked on the surface, but not inside, which therefore need a little more heat. Perfect for any type of food.



### Fan forced

The combination of the fan and the circular heating element (incorporated in the rear of the oven) allows you to cook different foods on several levels, as long as they need the same temperatures and type of cooking. Hot air circulation ensures instant and even distribution of heat. It will be possible, for instance, to cook fish, vegetables and biscuits simultaneously (on different levels) without mixing odours and flavours.



### Supercook

The combination of fan-assisted cooking and traditional cooking allows different foods to be cooked on several levels extremely quickly and efficiently, without odours and flavours mingling. Perfect for large volumes that call for intense cooking. (For multiple-level cooking, we recommend using the 1<sup>st</sup> and 4<sup>th</sup> shelves.)



### Fan forced + fan grill

The combination of fan-assisted cooking and traditional cooking allows you to cook different foods on several levels extremely quickly and efficiently, without odours and flavours mingling. Perfect for large volumes that call for intense cooking.



### Small grill

Using only the heat released from the central element, this function allows you to grill small portions of meat and fish for making kebabs, toasted sandwiches and any types of grilled vegetable side dishes.



## 3.6 Cooking advice

### General advice

- Use a fan-assisted function to achieve consistent cooking at several levels.
- It is not possible to shorten cooking times by increasing the temperature (the food could be overcooked on the outside and undercooked on the inside).
- To prevent excessive amounts of condensation from forming on the internal glass at the end of cooking, hot food should not be left inside the oven for too long after cooking.

### Advice for cooking meat

- Cooking times vary according to the thickness and quality of the food and to consumer taste.
- Use a meat thermometer when roasting meat, or simply press on the roast with a spoon. If it is hard, it is ready; if not, it needs another few minutes cooking.

### Advice for cooking with the Grill and the Fan grill

- Meat can be grilled even when it is put into the cold oven or into the preheated oven if you wish to change the effect of the cooking.
- With the Fan grill function, we recommend that you preheat the oven before grilling.
- We recommend placing the food at the centre of the rack.

### Advice for cooking desserts and biscuits

- Use dark metal moulds: they help to absorb the heat better.
- The temperature and the cooking time depend on the quality and consistency of the dough.

- To check whether the dessert is cooked right through: at the end of the cooking time, put a toothpick into the highest point of the dessert. If the dough does not stick to the toothpick, the dessert is cooked.
- If the dessert collapses when it comes out of the oven, on the next occasion reduce the set temperature by about 10°C, selecting a longer cooking time if necessary.

### Advice for defrosting and proving

- Place frozen foods without their packaging in a lidless container on the first shelf of the oven.
- Avoid overlapping the food.
- To defrost meat, use the rack placed on the second level and a tray on the first level. In this way, the liquid from the defrosting food drains away from the food.
- The most delicate parts can be covered with aluminium foil.
- For successful proving, a container of water should be placed in the bottom of the oven.

### To save energy

- Stop cooking a few minutes before the time normally used. Cooking will continue for the remaining minutes with the heat which has accumulated inside the oven.
- Reduce any opening of the door to a minimum to avoid heat dispersal.
- Keep the inside of the appliance clean at all times.
- (Where fitted) When it is not being used, remove the pizza plate and put the cover back in its slot.





## Timer during function

**i** This function only activates the buzzer, without stopping cooking.

1. Press the control knob during a cooking function.



2. Turn the control knob right or left to set the duration (from 1 minute to 4 hours). After a few seconds, the  symbol stops flashing and the countdown starts.
3. Wait for the buzzer to indicate that the time has finished. The  symbol flashes.

 Turn the knob right or left to select another timer or press the control knob to deactivate the buzzer.

## Timed cooking

**i** Timed cooking is the function which allows a cooking operation to be started and then ended after a specific length of time set by the user.

**i** Activation of timed cooking cancels any minute minder timer which may have been set previously.

1. After selecting a cooking function and temperature, press the control knob twice.
2. Turn the knob right or left to set the minutes of cooking from 00:01 to 13:00. Keep the knob turned to produce a faster increase or decrease.
3. A few seconds after the required duration is set, the  symbol stops flashing and timed cooking starts.







## Use

- At the end of the cooking time “function ended” appears on the display and a buzzer will sound that can be deactivated by pressing the control knob.



### Modifying the data set during timed cooking

During operation, it is possible to modify timed cooking duration:

- When the symbol  is steady and the appliance is cooking, press the control knob. The symbol  starts flashing.
- Turn the control knob right or left to alter the preset cooking duration.

### Delayed cooking



Delayed cooking is the function which allows a cooking operation to be stopped at an established time depending on the time set by the user, after which the oven will switch off automatically.

- After selecting a function and a cooking temperature, press the control knob to set the cooking time.

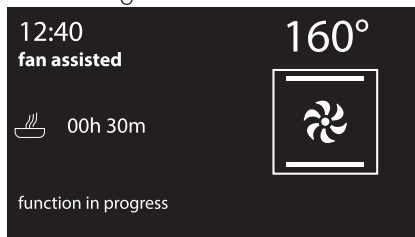

- Press the control knob before the  symbol stops flashing to set the cooking end time.



Turn the control knob to add some minutes of cooking time.





To extend the cooking time manually, press the control knob again. The appliance will resume its normal operation with the previously selected cooking settings.



To turn off the appliance see “Interrupting a function”.





- The  symbol flashes. Turn the knob right or left to set the end of cooking time.
- After a few seconds the  and  symbols stop flashing. The appliance waits for the delayed start time.

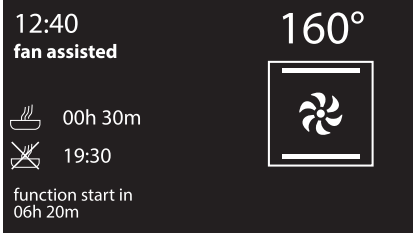

- Based on the values set, the appliance will start a preheating stage of approximately 10 minutes.

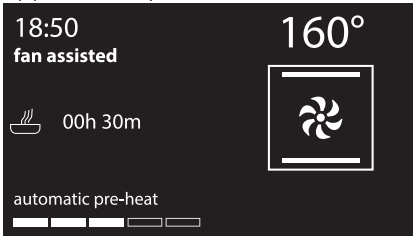

- It will then proceed with the selected function.

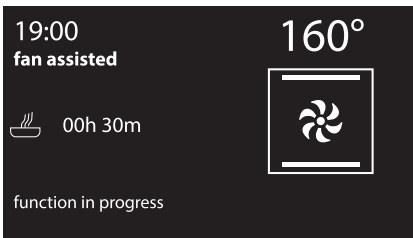

- At the end of the cooking time “function ended” appears on the display and a buzzer will sound that can be deactivated by pressing the control knob.



To extend the cooking time manually, press the control knob again. The appliance will resume its normal operation with the previously selected cooking settings.



For safety reasons, it is not possible to set the cooking end time by itself without setting the cooking duration.



## Modifying the data set during programmed cooking





After modifying the cooking time, the end of cooking time must be re-set.

During operation, it is possible to modify programmed cooking duration:



1. When the  and  symbols are lit steadily and the appliance is waiting for cooking to start, press the control knob.

The symbol  starts flashing.

2. Turn the control knob to alter the previously set cooking time.

3. Press the control knob again. The  symbol switches off and  starts flashing. The display shows the end of cooking time.

4. Turn the control knob to delay the end of cooking time.

5. After a few seconds the  and  symbols stop flashing and programmed cooking restarts its operation with the new settings.



If the cooking duration is modified, the end of cooking time is deleted.

## 3.7 Special functions

The special functions menu contains some functions like the timer with the oven off, defrost and cleaning functions.

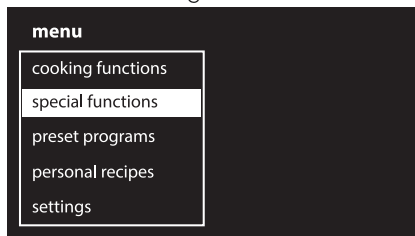

Certain functions are not available on all models.

### List of special functions



#### Timer

This function sounds a buzzer when the minutes set have elapsed.



#### Defrost by time

This function allows you to defrost food on the basis of a selectable time.



#### Defrost by weight

This function defrosts foods on the basis of the type and weight of the frozen product.



### Proving

The proving function, using the heat coming from the top, makes it possible to prove all types of dough, guaranteeing perfect results quickly.



### Food warming

To heat food or keep it hot.



### Sabbath mode

This mode allows food to be cooked while respecting the requirements of the Jewish Sabbath.



### Vapour clean (on some models only)

This function makes cleaning easier using the steam produced by a little quantity of water poured onto the appropriate drawing placed on the bottom.



### ECO Pyrolytic (on some models only)

When this function is set, the oven executes a pyrolytic cycle at 500°C for a pre-set time. For use in the case of ovens which are not too dirty.



### Pyrolytic (on some models only)

Setting this function, the oven reaches temperatures up to 500°C, destroying all the grease which forms on the internal walls.





The more complex special functions are illustrated below. For functions such as Vapour Clean, Pyrolytic and Eco Pyrolytic, see "4 Cleaning and maintenance".



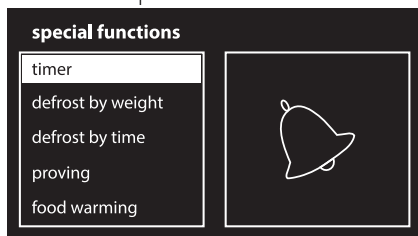

## Timer

1. Turn the control knob to the right or left to select **timer** from the "special functions" menu. Then press it to confirm.

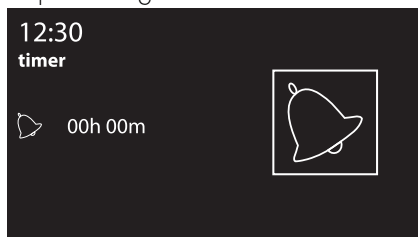

2. Turn the control knob right or left to set the duration (from 1 minute to 4 hours). After a few seconds, the  symbol stops flashing and the countdown starts.



3. If you leave the timer setting screen, the  symbol will be displayed at the top left, indicating that a minute minder timer is active.

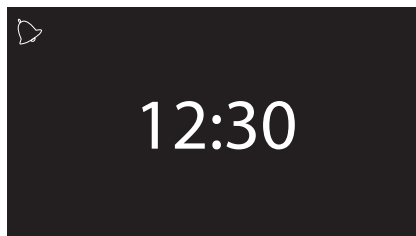

You must return the counter to zero to remove the special timer.



If a function is activated after setting a timer time, this time will be automatically used as a timer for the function, except for some special functions, automatic programs and personal recipes.



This function only activates the buzzer, without stopping cooking.



## Defrost by weight

1. Place the food inside the appliance.
2. Turn the control knob to the right or left to select **defrost by weight** from the “special functions” menu. Then press it to confirm.

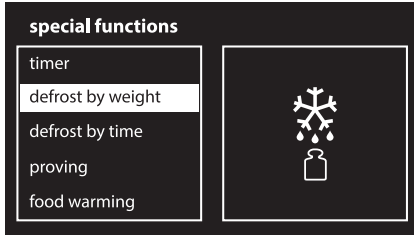

3. Turn the control knob to select the type of food to defrost.

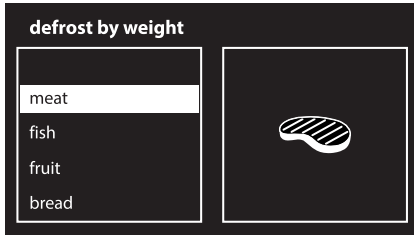

4. Turn the control knob to select the weight (in kilograms) of the food to defrost.

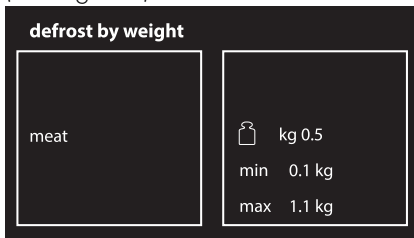

5. Press the control knob to confirm the set parameters.

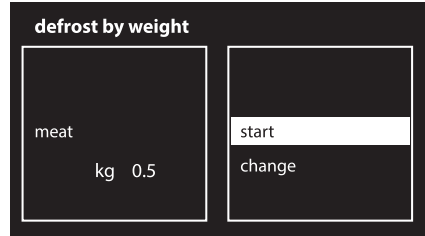

6. Press the control knob again to start defrosting, or select change to further modify the set parameters.

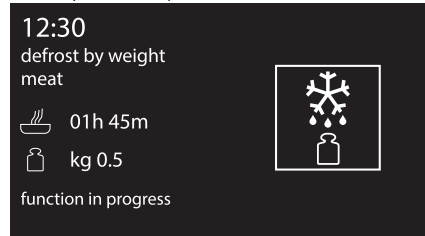





7. At the end of the cooking time “function ended” appears on the display and a buzzer will sound that can be deactivated by pressing the control knob.





# Use

Pre-set parameters:

Type	Weight (Kg)	Time (min)	
	Meat	0.1 to 1.1	01h 05m
	Fish	0.1 to 0.7	00h 05m
	Fruit	0.1 to 0.5	00h 35m
	Bread	0.1 to 0.5	00h 10m

## Defrost by time

1. Place the food inside the appliance.
2. Turn the control knob to the right or left to select **defrost by time** from the “special functions” menu. Then press it to confirm.

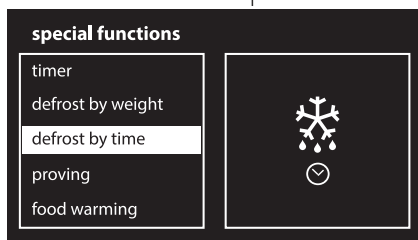

3. Turn the control knob to adjust the value (from 1 minute to 13 hours).

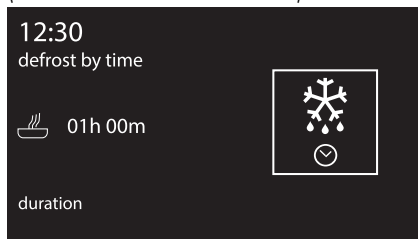

4. Press the control knob to confirm the parameters then press it again to start defrosting.
5. While the function is in progress, it is possible to further modify the defrosting duration. Turn the control knob to the right or left to make the required changes.
6. Press the control knob to confirm the new defrosting duration set. In any event, the defrosting will automatically resume 5 seconds from the last modification.
7. At the end of the cooking time “function ended” appears on the display and a buzzer will sound that can be deactivated by pressing the control knob.

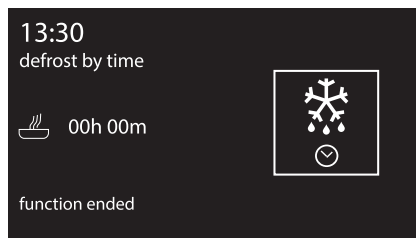



## Proving



For successful proving, a container of water should be placed in the bottom of the oven.

1. Position the dough to prove on the second level.
2. Turn the control knob to the right or left to select **proving** from the “special functions” menu. Then press it to confirm.

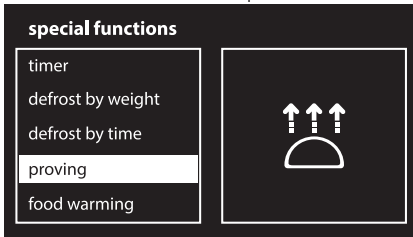

3. Press the control knob to start the function.

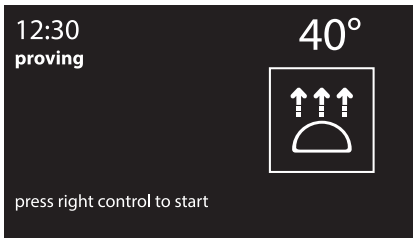

4. The appliance begins preheating.

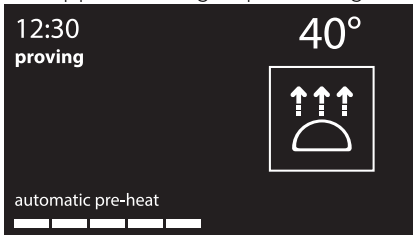

5. It will then proceed with the selected function.



6. While the function is in progress, it is possible to set a timer for a maximum of 4 hours (see “Timer during function”), a proving duration (see “Timed cooking”) or a delayed proving (see “Delayed cooking”). Press the control knob to make the required changes.

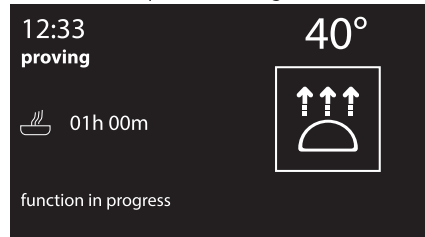

Unless otherwise set, the proving will have a maximum duration of 13 hours.



The light inside the oven will remain off during the proving function.



# Use

- At the end of the cooking time “function ended” appears on the display and a buzzer will sound that can be deactivated by pressing the control knob.

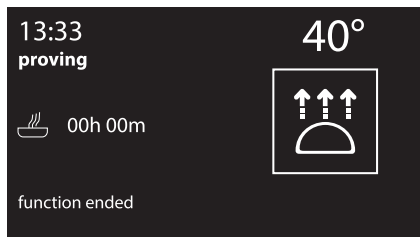

It is not possible to modify the temperature of the proving function.

## Food warming

- Position the tray on the first shelf and place the plates to be warmed in its centre.

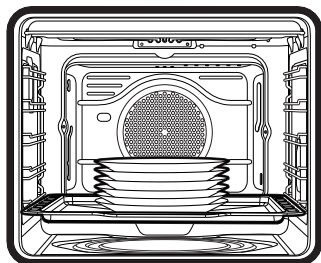

Do not stack plates too high. Stack plates a maximum of 5/6 high.

- Turn the control knob to the right or left to select **food warming** from the “special functions” menu. Then press it to confirm.

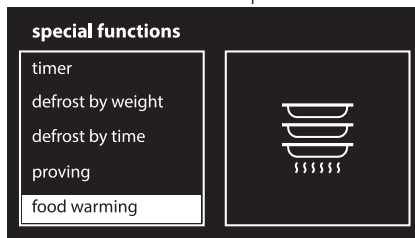

- Press the control knob to activate the function, or turn it to adjust the pre-set temperature (from 40° to 80°).



- The appliance begins preheating.

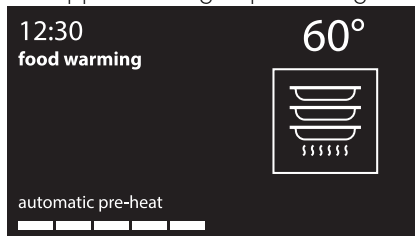

- It will then proceed with the selected function.







6. While the function is in progress, it is possible to set a timer for a maximum of 4 hours (see "Timer during function"), a warming duration (see "Timed cooking") or a delayed warming (see "Delayed cooking"). Press the control knob to make the required changes.

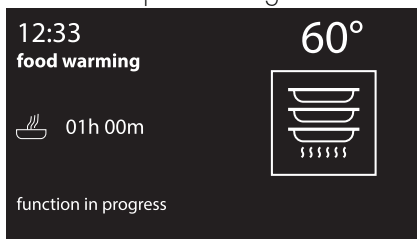

7. At the end of the cooking time "function ended" appears on the display and a buzzer will sound that can be deactivated by pressing the control knob.

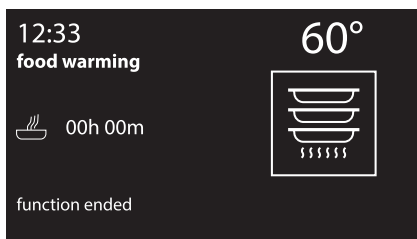

## Sabbath mode



The appliance follows some specific behaviour when operating in this function:

- Cooking can proceed indefinitely, it is not possible to set any cooking duration.
- No preheating will be performed.
- The cooking temperature which can be selected varies between 60-100 °C.
- Oven light disabled, any operation such as opening the door or manual activation with the knob will not activate the light.
- Oven fan disabled.
- Knob lights and buzzers disabled.



After activating the Sabbath mode it will no longer be possible to modify any parameters.

Any action on the knobs will produce no effect; only the control knob remains active to allow you to return to the main menu.



# Use

1. Turn the control knob to the right or left to select **sabbath mode** from the "special functions" menu. Then press it to confirm.

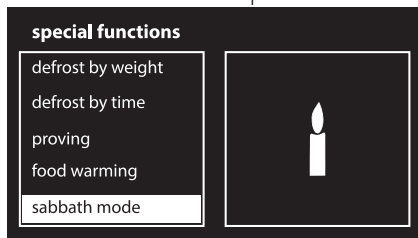

2. Turn the control knob to the right or left to change the heating temperature.

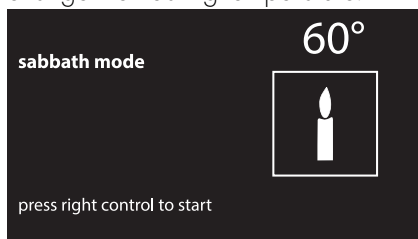

3. Press the control knob to confirm the parameters and start the Sabbath mode.

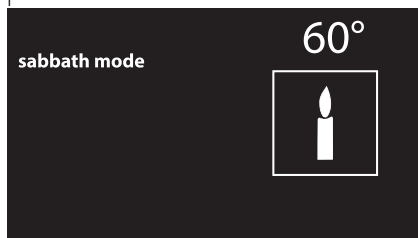

4. When finished, press and hold the control knob for at least 5 seconds to return to the main menu.

## 3.8 Preset programs

This mode allows you to select a pre-set food cooking program. The appliance will automatically calculate the optimum cooking parameters based on the weight entered.

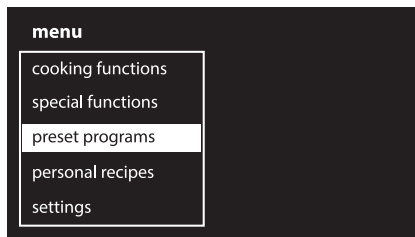

### Starting a program

1. Turn the control knob to the right or left to select the required type of dish from the "preset programs" menu. Then press it to confirm.

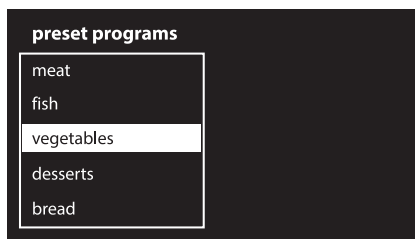

2. Select the sub-category of dish to cook and press the control knob to confirm.

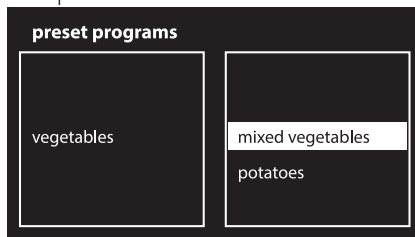



3. Select the type of cooking (where possible, depending on the dish chosen) and press the control knob to confirm.

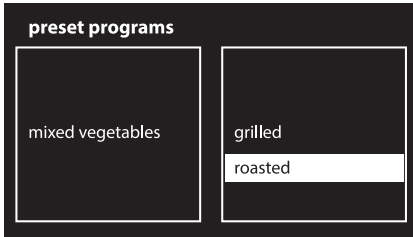

4. Turn the control knob to select the dish weight.

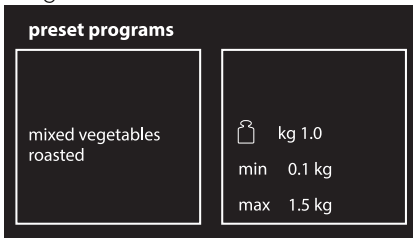

5. At this point it is possible to start the selected preset program, permanently modify the settings or perform delayed cooking.

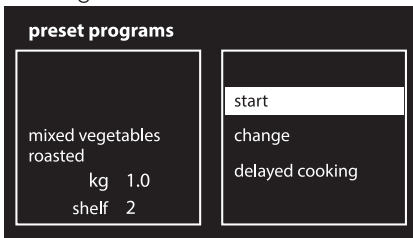

6. If you choose the **Start** option, cooking will start with the preset program's predefined settings and the display will show all the parameters set.

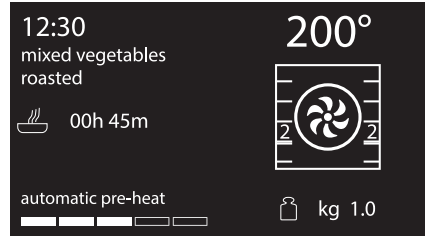

The time shown does not include the automatic reheat time.



Some predefined cooking parameters can be changed at any time, even after cooking has started.

7. A message will indicate when to place the food in the oven and enable the start of cooking.

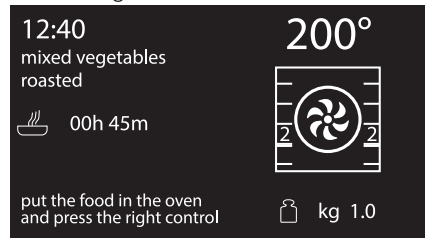

8. Press the control knob to start cooking.

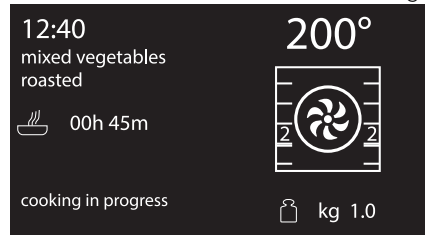



# Use

## Ending a preset program

1. When the preset program has finished, the appliance will warn the user with buzzers and the flashing  symbol.

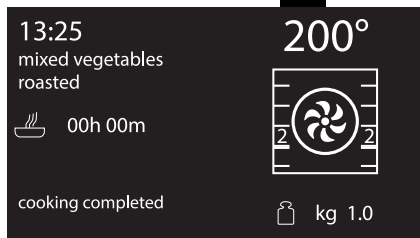

2. Press the control knob to perform cooking with the same parameters currently set (press the knob twice if the buzzer is active). The appliance will automatically restart cooking if it is at the correct temperature; otherwise it will also resume preheating.

**i** Cooking in sequence is useful to cook multiple dishes of the same type. For example, it can be used to cook several pizzas in a row.

 It is not recommended to place the dish in the oven during the automatic pre-heat stage. Wait for the specific message.

3. Press the return knob to exit and end the preset program.

## Changing a preset program permanently

1. Inside the selected preset program, turn the control knob to the left or right to select **change** from the menu of the selected dish. Then press it to confirm.

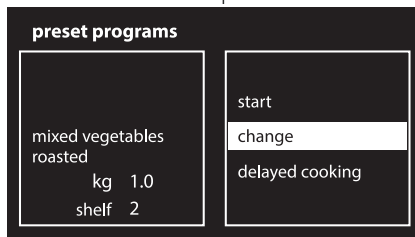

2. Turn the control knob to the right or left to select the **function** to associate with the preset program. Press the control knob to confirm.

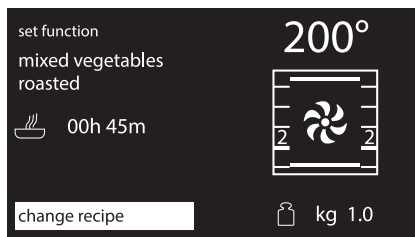

3. Turn the control knob to the right or left to select the **weight** to associate with the preset program. Press the control knob to confirm.

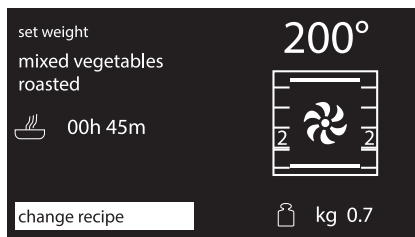



4. Turn the control knob to the right or left to select the **duration** to associate with the preset program. Press the control knob to confirm.

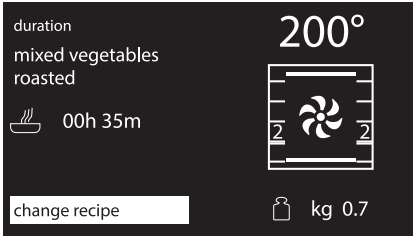

5. Turn the control knob to the right or left to select the **temperature** to associate with the preset program. Press the control knob to confirm.

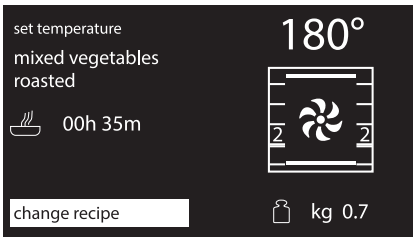

6. Turn the control knob to the right or left to select the **shelf** to associate with the preset program. Press the control knob to confirm.

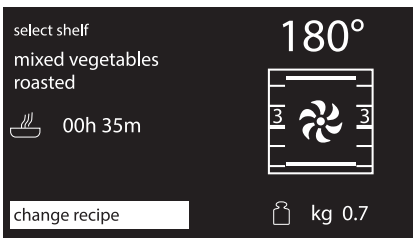

7. Pressing the control knob again will return to point 2 of the change sequence. You must press the return knob to save the preset program. The appliance will ask to confirm the changes which have just been made.

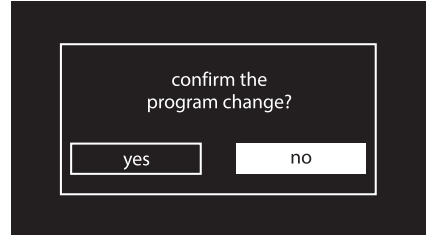

**i** If the changes are not confirmed, the program will remain unchanged.

8. If the changes are confirmed the display will show confirmation of this.

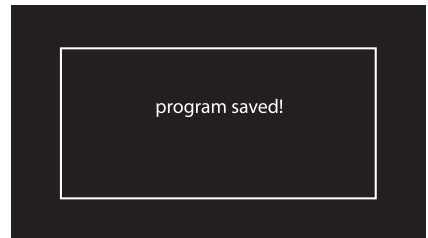



# Use

## Preset program table

### MEATS

Subcategory	Cooking	Weight (Kg)	Function	Level	Temp. (°C)	Time (minutes)
Roast beef	rare	1	Fan forced	2	200	35
	medium	1	Fan forced	2	200	40
	well done	1	Fan forced	2	200	45
Pork loin	-	1	Supercook	2	190	75
Lamb	medium	1	Supercook	2	190	100
	well done	1	Supercook	2	190	110
Veal	-	1	Fan assisted	2	190	65
Pork spare ribs	-	1	Fan grill	4	250	16
Pork chops	-	1	Fan grill	4	280	15
Pork sausages	-	1	Fan grill	4	280	12
Bacon	-	0.5	Fan grill	4	250	7
Turkey	roasted	3	Fan assisted	1	190	110
Chicken	roasted	1	Supercook	2	200	64
Rabbit	roasted	1.5	Fan forced	2	190	80

### FISH

Subcategory	Cooking	Weight (Kg)	Function	Level	Temp. (°C)	Time (minutes)
Fresh fish	-	0.5	Fan assisted	2	160	35
Frozen fish	-	0.5	Fan forced	2	160	45
Firm fish	-	1	Fan forced	2	160	45
Delicate fish	-	0.8	Fan forced	2	160	60
Snapper	-	1	Fan forced	2	180	30
Snapper	-	1	Fan forced	2	160	35

### VEGETABLES

Subcategory	Cooking	Weight (Kg)	Function	Level	Temp. (°C)	Time (minutes)
Mixed vegetables	grilled	0.5	Grill	4	250	25
	roasted	1	Fan forced	2	200	45
Potatoes	roasted	1	Supercook	2	220	40
	Frozen fried	0.5	Fan assisted	2	220	13



## DESSERTS/PASTRIES

Subcategory	Cooking	Weight (Kg)	Function	Level	Temp. (°C)	Time (minutes)
Ring cake	-	1	Fan assisted	2	160	60
Biscuits	-	0.6	Supercook	2	160	18
Muffins	-	0.5	Fan forced	2	160	18
Profiteroles	-	0.5	Supercook	2	180	70
Meringues	-	0.3	Supercook	2	120	90
Sponge cake	-	1	Fan forced	2	160	60
Strudel	-	1	Convection	2	170	40
Tarts	-	0.8	Convection	2	170	40
Brioche bread	-	1	Fan assisted	2	180	40
Croissants	-	0.6	Fan forced	2	160	30

## BREAD

Subcategory	Cooking	Weight (Kg)	Function	Level	Temp. (°C)	Time (minutes)
Leavened bread	-	1	Fan forced	2	200	30
Focaccia	-	1	Supercook	2	180	25

## PIZZA

Subcategory	Cooking	Weight (Kg)	Function	Level	Temp. (°C)	Time (minutes)
Pan baked pizza	-	1	Fan assisted	1	280	7
Stone baked pizza	fresh	0.5	Fan assisted	1	280	4
	frozen	0.3	Fan assisted	1	230	6

## PASTA/RICE

Subcategory	Cooking	Weight (Kg)	Function	Level	Temp. (°C)	Time (minutes)
Pasta bake	-	2	Convection	1	220	40
Lasagne	-	2	Convection	1	230	35
Paella	-	0.5	Fan assisted	2	190	25
Quiche	-	0.5	Convection	1	200	30
Soufflé	-	0.5	Fan forced	2	180	25



## Use

### SLOW COOKING

Subcategory	Cooking	Weight (Kg)	Function	Level	Temp. (°C)	Time (minutes)
Veal	-	1	Supercook	2	90	360
Beef	rare	1	Convection	2	90	105
	well done	1	Convection	2	90	380
Pork	-	1	Supercook	2	90	330
Lamb	-	1	Supercook	2	90	360



The cooking times in the table refer to the food indicated in the recipe and are a guide only; they may vary depending on personal taste.



The tables give the factory-set data. To reset a predefined program with the original settings after it has been changed permanently, just enter the data given in the table above.



If ECO logic mode (see 3.9 Personal recipes) has been activated, cooking times or preheating times may vary.





## Auxiliary oven cooking information table

Food	Weight (Kg)	Function	Runner position from the bottom	Temperature (°C)	Time (minutes)	
Lasagne	3 / 4	Static	1 or 2	220 - 230	50 - 60	
Pasta bake	2	Static	1 or 2	220 - 230	40	
Roast veal	1	Static	2	180 - 190	70 - 80	
Pork loin	1	Static	2	180 - 190	70 - 80	
Pork shoulder	1	Static	2	180 - 190	90 - 100	
Roast rabbit	1	Static	2	180 - 190	70 - 80	
Turkey breast	1.5	Static	2	180 - 190	89 - 90	
Roast chicken	1	Static	2	190 - 200	55 - 60	
					<b>1<sup>nd</sup> surface</b>	<b>2<sup>nd</sup> surface</b>
Pork chops	1	Grill	4	250 - 280	7 - 9	5 - 7
Pork fillet	1	Grill	3	250 - 280	9 - 11	5 - 9
Sausages	1	Grill	3	250 - 270	7 - 9	5 - 6
Bacon	0.8	Grill	1/2/3/4	270	6 - 7	3 - 4
Salmon trout	1	Static	1	250 - 270	14 - 16	
Pizza	1	Static	1	280	8	
Focaccia	0.8	Static	2	180 - 190	15 - 20	
Fruit tart		Static	1	170 - 180	35 - 40	
Short pastry		Static	1	170 - 180	20 - 25	
Rice pudding	1	Static	1	170 - 180	50 - 60	
Apple pie	0.5	Static	2	180	60	

The times indicated in the table do not include preheating times and are provided as a guide only.



## 3.9 Personal recipes

This menu allows you to enter a personal recipe with the parameters you wish to use. On first use, the appliance will only offer to let you add a new recipe. After storing your personalised recipes, these will then be available in the relative menu.



**i** Up to 10 personal recipes can be stored.

### Adding a recipe

1. Select **add** from the personal recipes menu.



2. Turn the control knob to the right or left to select the **function** to associate with the recipe. Press the control knob to confirm.

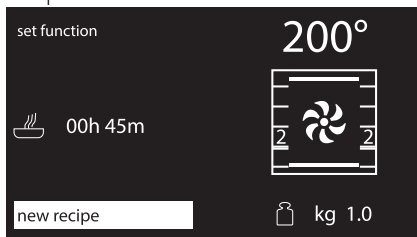

3. Turn the control knob to the right or left to select the **weight** to associate with the recipe. Press the control knob to confirm.

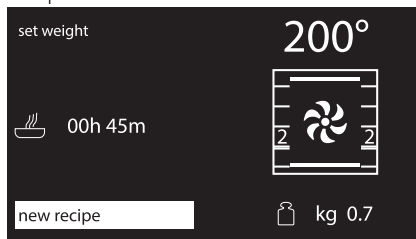

**i** The weight can be set or modified up to 5 kg, but the user is responsible for ensuring that the dish will fit correctly inside the oven.

4. Turn the control knob to the right or left to select the **duration** to associate with the recipe. Press the control knob to confirm.

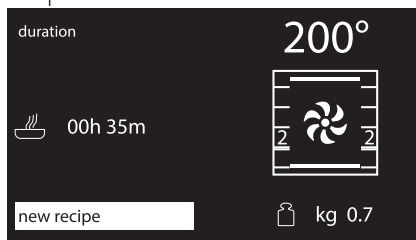

5. Turn the control knob to the right or left to select the **temperature** to associate with the recipe. Press the control knob to confirm.

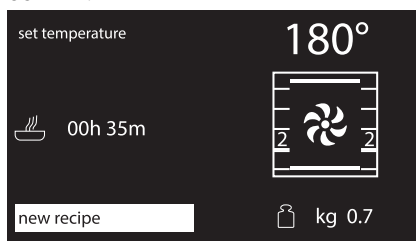



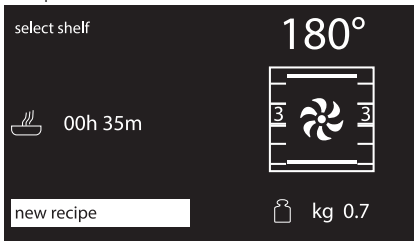

6. Turn the control knob to the right or left to select the **shelf** to associate with the recipe. Press the control knob to confirm.

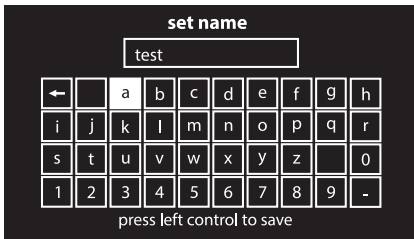

7. Pressing the control knob again will return to point 2 of the change sequence. You must press the return knob to save the recipe. The appliance will ask you to enter a name for the recipe you have just created.



8. Enter the name of the recipe. Turn the control knob to select the characters to enter. Each time the control knob is pressed, a character of the name will be entered. The  character deletes the previous letter.

**i** The recipe name can contain maximum 10 characters, including spaces.

**i** In order to be able to save the recipe, the name must contain at least one character.

9. After entering the name of your recipe, press the return knob to confirm or cancel the information you have entered. Select **YES** if you wish to store the recipe.

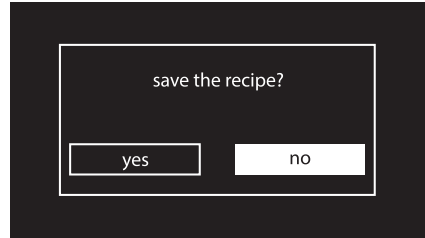

**i** If you select "NO", you will lose all changes made.

10. If the changes are confirmed the display will show confirmation of this.





## Starting a personal recipe

1. Turn the control knob to the right or left to select a previously stored **personal recipe** from the “personal recipes” menu (in the example, the recipe **test** has been stored). Press the control knob to confirm.



2. Turn the control knob to the right or left to select **start**. Press the control knob to confirm.

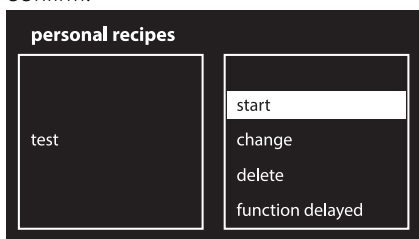

3. Cooking will start with the parameters previously set for the recipe.

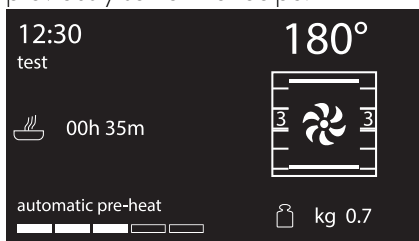

## Changing a personal recipe

1. Turn the control knob to the right or left to select a previously stored **personal recipe** from the “personal recipes” menu (in the example, the recipe **test** has been stored). Press the control knob to confirm.



2. Turn the control knob to the right or left to select **change**. Press the control knob to confirm.



3. Repeat the same steps, starting at point 2 of the chapter “Adding a recipe”.

## Deleting a personal recipe

1. Turn the control knob to the right or left to select a previously stored **personal recipe** from the “personal recipes” menu (in the example, the recipe **test** has been stored). Press the control knob to confirm.



During cooking it is always possible to modify the temperature and cooking time, but this will not be saved to the recipe for future use.



- Turn the control knob to the right or left to select **delete**. Press the control knob to confirm.

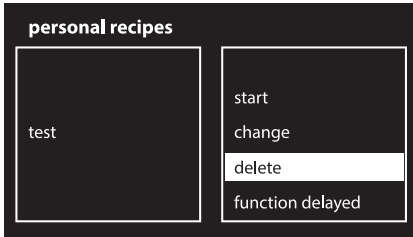

- Confirm the deletion. Select YES to delete the recipe permanently.



- If you confirm the deletion, the display will show a confirmation message.





## Delayed cooking

- Turn the control knob to the right or left to select a previously stored **personal recipe** from the "personal recipes" menu (in the example, the recipe **test** has been stored). Press the control knob to confirm.

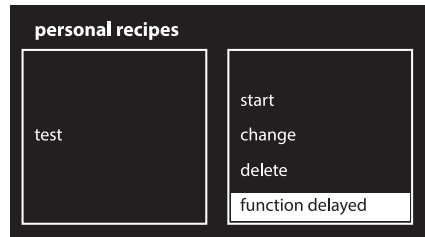

- Turn the control knob to the right or left to select **function delayed**. Press the control knob to confirm.



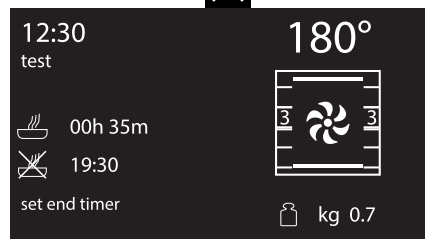

- Turn the control knob to the right or left to select the cooking end time with the control knob. The  symbol flashes.



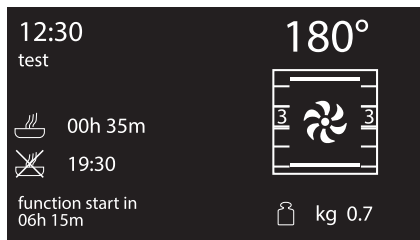

4. Press the control knob to confirm.



5. After a few seconds the  symbol stops flashing. The appliance waits for the delayed start time.

2. Turn the control knob to the right or left to select the required language. Press the control knob to confirm.

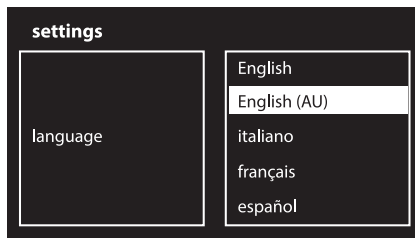

3. Confirm the selected language.

## 3.10 Settings

The product configuration can be set using this menu.



## Clock

Sets the time displayed.

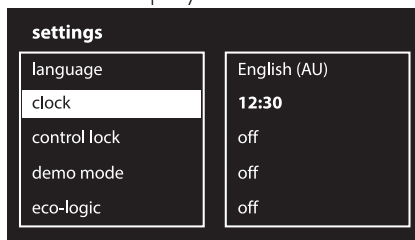

## Language

Sets the interface language from those available.

1. Turn the control knob right or left to set the hour.
2. Press the control knob to move to changing the minutes.
3. Turn the control knob right or left to set the minutes.
4. Press the return knob to confirm.

1. Turn the control knob to the right or left to select **language** from the "settings" menu. Press the control knob to confirm.

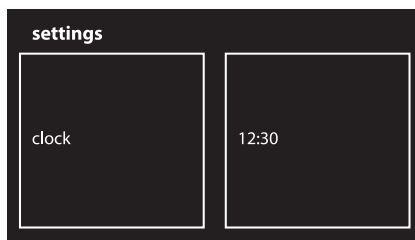
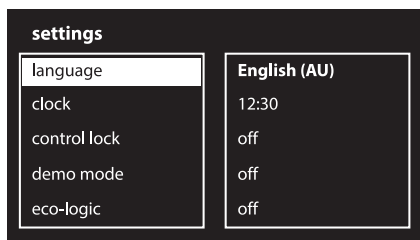



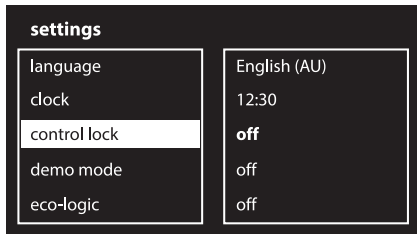

## Control lock

Allows the appliance to lock the controls automatically after one minute of normal operation without any intervention from the user.

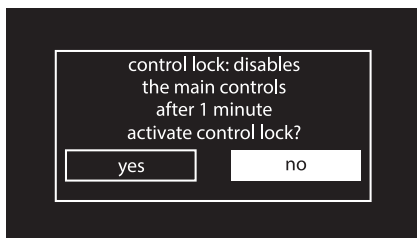

To confirm activation of the control lock, select **YES**.



During normal operation it is indicated by the  indicator light coming on.

To release the lock temporarily during cooking, hold the return knob down for 3 seconds. One minute after the last setting the lock will become active again.



Touching or varying the position of the control and return knobs, the display will show a warning for two seconds.

## Demo mode (for exhibitors only)

This mode allows the appliance to deactivate all heating elements, while keeping the control panel active.

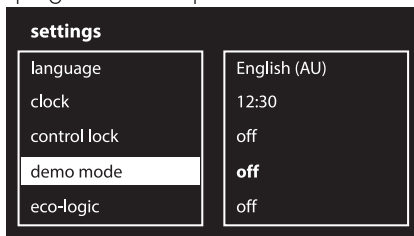

To confirm activation of the demo mode, select **YES**.

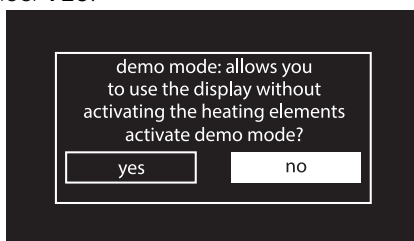

If the mode is active, "demo mode" will be shown on the display.



To use the appliance normally, set this mode to **OFF**.



# Use

## Eco-Logic

This mode allows the appliance to limit the power used. Indicated for use of multiple home appliances at the same time.

If this option is enabled, the  symbol will appear on the display.

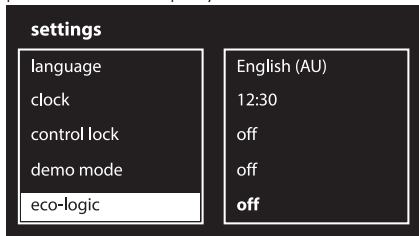

To confirm activation of the eco-logic mode, select **YES**.

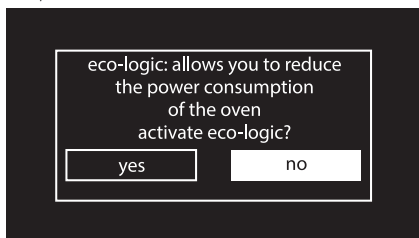

Activating eco-logic mode means that preheating and cooking times may be extended.

## Sound

Whenever one of the knobs is pressed, the appliance beeps. This setting disables these sounds.

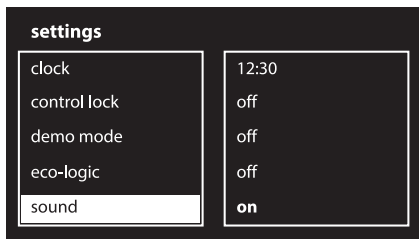

To disable sounds when the knobs are pressed, select **NO**.

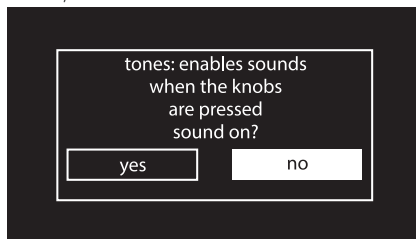

## Keep warm

This mode allows the appliance to keep cooked food warm (at low temperatures)

after cooking finishes with a cooking cycle for which a duration has been set (if this is not manually interrupted), without altering the taste and aromas obtained during cooking.

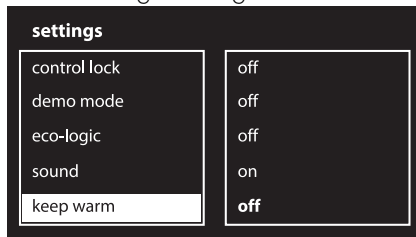

To confirm activation of the keep warm mode, select **YES**.

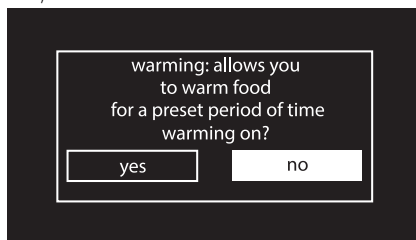





## Eco-Light

For greater energy savings, the light is automatically deactivated one minute after the start of cooking.

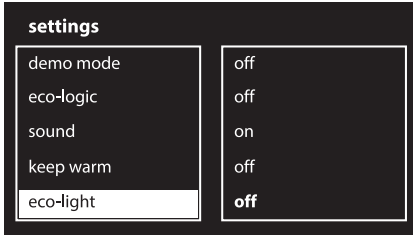

To confirm activation of the eco-light mode, select **YES**.

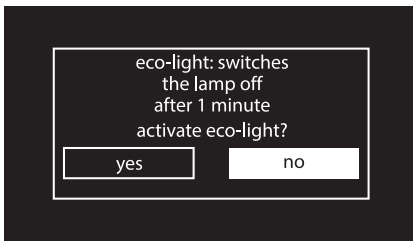

To stop the appliance from automatically deactivating the light after one minute, set this mode to OFF.



The manual off/on control is always available with both settings by turning the return knob to the right.

## Digital clock

Displays the time in digital format.

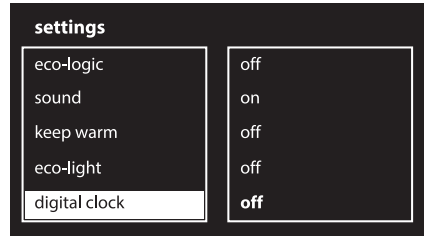

To confirm activation of the digital clock, select **YES**.

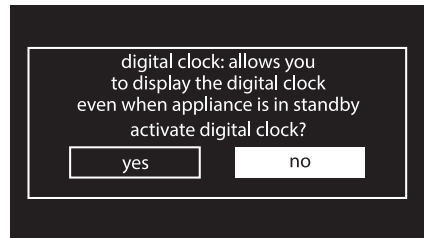

When no appliance function is active, the display will show the current time in digital format.

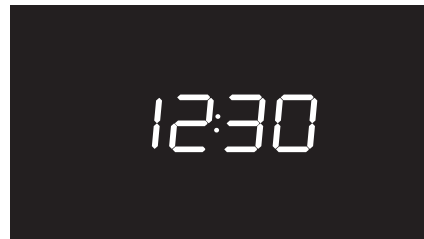



# Cleaning and maintenance

## 4 Cleaning and maintenance

### 4.1 Instructions



**Improper use**  
**Risk of damage to surfaces**

- Do not use steam jets to clean the appliance.
- Do not use cleaning products containing chlorine, ammonia or bleach on steel parts or parts with metallic finishes on the surface (e.g. anodizing, nickel- or chromium-plating).
- Do not use abrasive or corrosive detergents on glass parts (e.g. powder products, stain removers and metallic sponges).
- Do not use rough or abrasive materials or sharp metal scrapers.

### 4.2 Cleaning the surfaces

To keep the surfaces in good condition, they should be cleaned regularly after use. Let them cool first.

### 4.3 Ordinary daily cleaning

Always use only specific products that do not contain abrasives or chlorine-based acids.

Pour the product onto a damp cloth and wipe the surface, rinse thoroughly and dry with a soft cloth or a microfibre cloth.

### 4.4 Food stains or residues

Do not use metallic sponges or sharp scrapers as they will damage the surfaces. Use ordinary non-abrasive products with the aid of wooden or plastic utensils if necessary. Rinse thoroughly and dry with a soft cloth or a microfibre cloth.

Do not allow residues of sugary foods (such as jam) to set inside the oven. If left to set for too long, they might damage the enamel lining of the oven.

### 4.5 Removing the door

For easier cleaning, the door can be removed and placed on a canvas.

To remove the door proceed as follows:

1. Open the door completely and insert two pins into the holes on the hinges indicated in the figure.

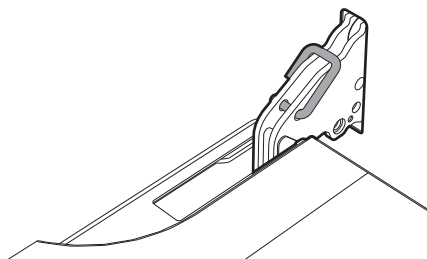

2. Grasp the door on both sides with both hands, lift it forming an angle of around 30° and remove it.

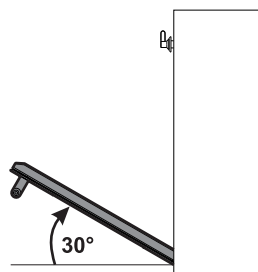



- To reassemble the door, put the hinges in the relevant slots in the oven, making sure that grooved sections **A** are resting completely in the slots. Lower the door and once it is in place remove the pins from the holes in the hinges.

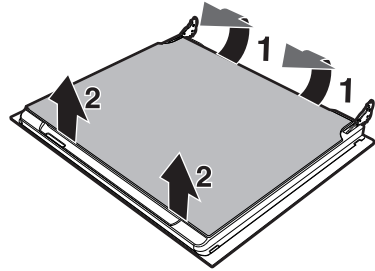
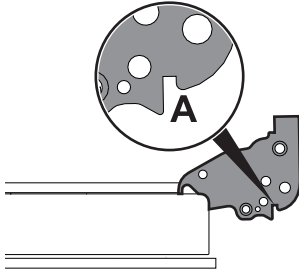

- Some models have an intermediate glass panel. Remove the intermediate glass panel by lifting it upwards.

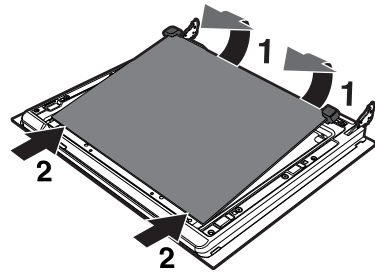

## 4.6 Cleaning the door glazing

The glass in the door should always be kept thoroughly clean. Use absorbent kitchen roll. In case of stubborn dirt, wash with a damp sponge and an ordinary detergent.



We recommend the use of cleaning products distributed by the manufacturer.

## 4.7 Removing the internal glass panels

For easier cleaning the door internal glass panels can be disassembled.

- Remove the internal glass panel by pulling the rear part gently upwards, following the movement indicated by the arrows (1).
- Then, pull the front part upwards (2). In this way, the 4 pins attached to the glass detach from their housings in the oven door.

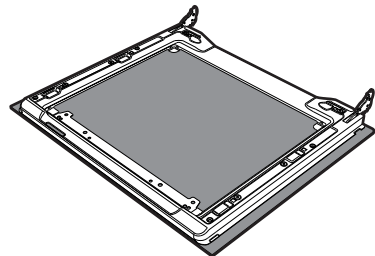

- Refit the panels in the reverse order in which they were removed.



## Cleaning and maintenance

6. Reposition the internal glass panel. Take care to centre and insert the 4 pins into their housings in the oven door by applying slight pressure.

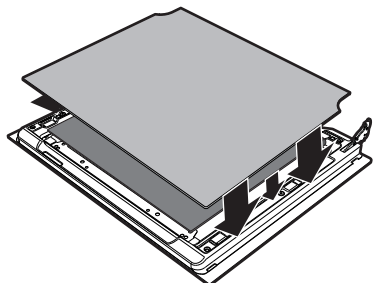

### 4.8 Cleaning the inside of the oven

For the best oven upkeep, clean it regularly after having allowed it to cool.

Take out all removable parts.

Clean the oven racks with warm water and non-abrasive detergent. Carefully rinse and dry damp parts.



### Removing racks/trays support frames

Removing the guide frames enables the sides to be cleaned more easily. This operation should be performed each time the automatic cleaning cycle is used (on some models only).

To remove the guide frames: Pull the frame towards the inside of the oven to unhook it from its groove **A**, then slide it out of the seats **B** at the back.

When cleaning is complete, repeat the above procedures to put the guide frames back in.

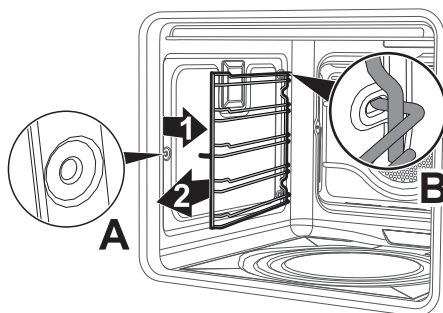

The oven should be operated at the maximum temperature for about 15-20 minutes after the use of specific products, to burn off the residues left inside the oven.



For easier cleaning, remove the door.



## 4.9 Pyrolytic (main oven only)



Pyrolytic is an automatic high-temperature cleaning procedure which causes dirt to dissolve. Thanks to this process, it is possible to clean the inside of the oven very easily.



### Improper use Risk of damage to surfaces

- Remove any food residues or large spills from previous cooking operations from the inside of the oven.
- Switch off the burners or electric hot plates of the hob installed above the oven.

### Preliminary operations

Before starting the pyrolytic cycle:

- Clean the internal glass panel following the usual cleaning instructions.
- For very stubborn encrustations spray an oven cleaning product onto the glass (read the warnings on the product); leave for 60 minutes, then rinse and dry the glass using kitchen roll or a microfibre cloth.
- Completely remove all accessories from inside the oven.
- Remove the racks/trays support frames.
- Remove the upper guard (if present).
- Close the door.

### Pyrolytic function setting

1. Turn the control knob to the right or left to select **eco pyrolytic** or **pyrolytic** from the "special functions" menu. Then press it to confirm.

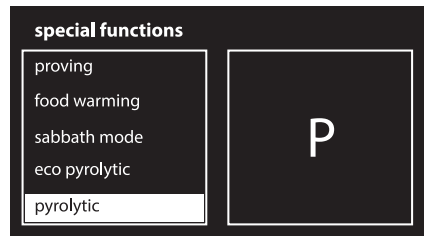
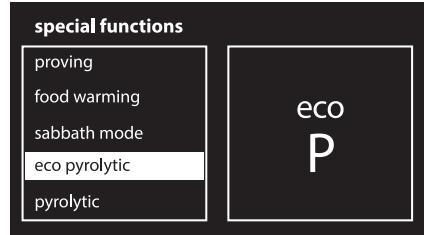

2. Turn the control knob to set the cleaning cycle duration from a minimum of 2 hours to a maximum of 3 hours (except for the **ECO P** function whose duration is 2 hours).

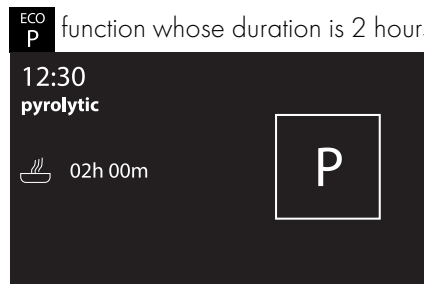



## Cleaning and maintenance

3. Press the control knob. The  symbol will now be lit solidly. The display shows a warning to remove accessories from inside the oven cavity.
4. Press the control knob to start the pyrolytic cycle.



Recommended pyrolytic cycle duration:

- Light dirt: 2 hours.
- Medium dirt: 2 ½ hours.
- Heavy dirt: 3 hours.

### Pyrolytic

12:45  
pyrolytic

 01h 45m

cleaning in progress



1. The display shows “cleaning in progress” and the remaining time to indicate that the appliance is carrying out the automatic cleaning cycle. Two minutes after the pyrolytic cycle has started the door is locked (the door lock indicator light  comes on) by a device that prevents the door from being opened.



It is not possible to select any function once the door lock device has been activated.

2. At the end of the pyrolytic cycle, the door remains locked as long as the temperature inside the oven returns to safety levels.

14:30

pyrolytic

 00h 00m

end of cleaning  
cooling in progress



3. The display indicates that the cooling procedure inside the oven cavity is in progress. Wait for the oven to cool down and collect the residues deposited inside with a damp microfibre cloth.



During the first pyrolytic cycle, unpleasant odours may occur due to the normal evaporation of oily manufacturing substances. This is an absolutely normal phenomenon which disappears after the first pyrolytic cycle.



During the pyrolytic cycle the fans produce a more intense level of noise due to a greater rotation speed. This is an absolutely normal operation, intended to provide more effective heat dispersal. At the end of the pyrolytic cycle, the fans will continue to operate for long enough to avoid overheating the walls of adjacent units and the front of the oven.





If the pyrolytic cycle gives unsatisfactory results at minimum duration, it is recommended to set a longer time for successive cleaning cycles.



## Setting of programmed pyrolytic cycle

It is possible to program the pyrolytic cycle start time.

1. After selecting the pyrolytic cycle duration, press the control knob. The display shows the current time and the  symbol comes on.
2. Turn the control knob to set the time you wish the pyrolytic cycle to finish.
3. After a few seconds, the  and  symbols remain lit steadily and the appliance waits for the set start time to start the cleaning cycle.



It is not possible to select any function once the door lock device has been activated. It remains possible, however, to switch off the appliance using the specific controls.

3. Remove the bulb cover using a tool (e.g. a screwdriver).

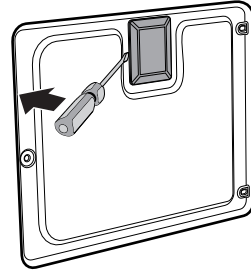

4. Slide out and remove the lamp.

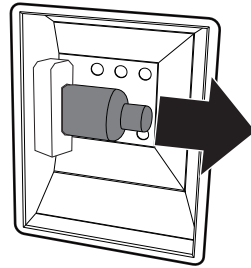

## 4.10 Extraordinary maintenance



Live parts  
**Danger of electrocution**

- Disconnect the oven power supply.

## Replacing the internal light bulb

1. Completely remove all accessories from inside the oven.
2. Remove the racks/trays support frames.



Do not touch the halogen lamp directly with your fingers, but wrap it in an insulating material.

5. Replace the lamp with one of the same type (40W).
6. Refit the cover correctly, so that the moulded part of the glass is facing the door.
7. Press the cover completely down so that it attaches perfectly to the bulb support.



## Cleaning and maintenance

### Removing the door seal (auxiliary oven only)

To permit thorough cleaning of the oven, the door seal may be removed. There are fasteners on all four sides to attach it to the edge of the oven. Pull the 4 edges of the seal outwards to detach the fasteners.

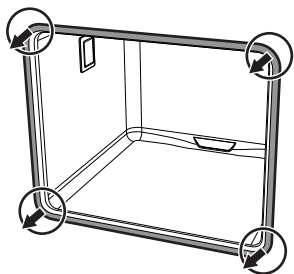

### What to do if...

The display is completely off:

- Check the mains power supply.
- Check whether an omnipolar switch upstream of the appliance supply line is in the "ON" position.

The appliance does not heat up:

- Check whether it has been set in "demo" mode (for further details see "Settings").

The controls do not respond:

- Check whether it has been set to "control lock" mode (for further details see "Settings").

The cooking times are longer than those indicated in the table:

- Check whether it has been set to "eco-logic" mode (for further details see "Settings").

After the automatic cleaning cycle (pyrolytic) it is not possible to select a function:

- Verify whether the door lock has deactivated. If it has not, the oven has a safety device that does not allow functions to be selected while the door lock is active. This is because the temperature inside the oven is still too high to permit any type of cooking.

The display shows "Error 4":

- The door lock has not properly attached to the door. This might be because the door was accidentally opened during the door lock activation. Switch the oven off and on again, waiting a few minutes before selecting a new cleaning cycle.

If the door is opened during a fan-assisted function, the fan stops:

- This is not a fault. It is a normal operation of the appliance, useful when cooking foods in order to avoid excessive heat escaping. When the door is closed, the oven will return to normal operation.



If the problem has not been resolved or in the case of other types of fault, contact your local technical support centre.



If other Error XX error messages are indicated:  
note down the error message, function and set temperature and contact your local technical support centre.





## 5 Installation

### 5.1 Electrical connection



**Power voltage  
Danger of electrocution**

- Have the electrical connection performed by authorised technical personnel.
- The appliance must be connected to earth in compliance with electrical system safety standards.
- Disconnect the main power supply.

#### General information

Check the grid characteristics against the data indicated on the plate.

The identification plate bearing the technical data, serial number and brand name is visibly positioned on the appliance.

Do not remove this plate for any reason.

The appliance works at 220-240 V~.

Perform the ground connection using a wire that is 20 mm longer than the other wires.

#### Connection modes:

- 220-240 V 1N~

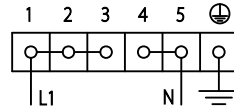

Use a **3 x 4 mm<sup>2</sup> three-core** cable.

- 380-415 V 2N~

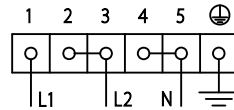

Use a **4 x 2.5 mm<sup>2</sup> four-core** cable.

- 380-415 V 3N~

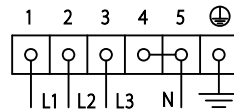

Use a **5 x 2.5 mm<sup>2</sup> five-core** cable.

#### Fixed connection

Fit the power line with an omnipolar circuit breaker in compliance with installation regulations.

The circuit breaker should be located near the appliance and in an easily reachable position.

#### Connection with plug and socket

Make sure that the plug and socket are of the same type.

Avoid using adapters and shunts as these could cause overheating and a risk of burns.



# Installation

## 5.2 Cable replacement



Power voltage  
**Danger of electrocution**

- Disconnect the main power supply.

1. Unscrew the fastening screws **2** of the terminal board cover.

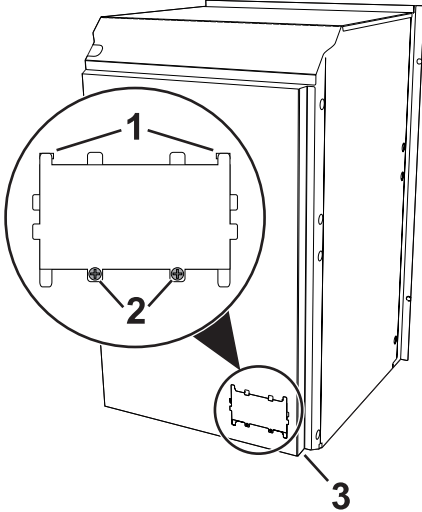

2. Slide the tabs **1** of the terminal board cover out of the grooves;
3. Loosen the screw of the cable retention bracket in the right lower part of the oven back **3**;
4. Make sure that the cables (for the oven or any hob) follow the best route in order to avoid any contact with the appliance.

## 5.3 Positioning



Heavy appliance  
**Danger of crush injuries**

- Place the appliance into the piece of furniture with the aid of a second person.



Pressure on the open door  
**Risk of damages to the appliance**

- When positioning the appliance during installation, do not use the door handle to lift up or move this appliance.
- Never use the oven door to lever the appliance into place when fitting.
- Avoid exerting too much pressure on the oven door when open.



Heat production during appliance operation  
**Risk of fire**

- Check that the piece of furniture material is heat resistant.
- Check that the piece of furniture has the required slots.



## Fixing

To secure the appliance to the counter, screw in 6 screws through the holes in the frame.

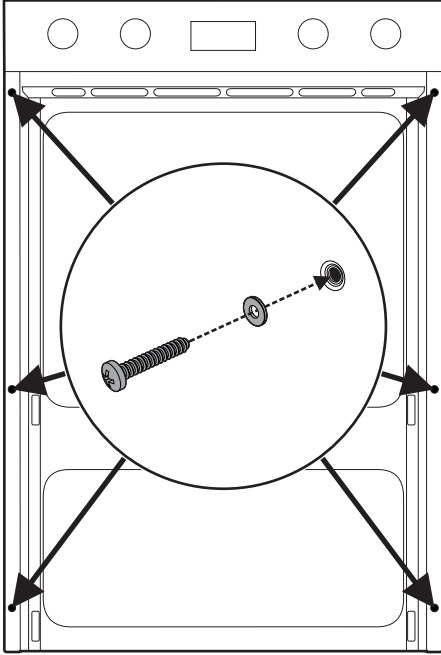

## Mounting (mm)

The oven is designed for mounting into any piece of furniture as long as it is heat-resistant. Respect the unit dimensions and the oven overall dimensions for positioning. Depending on the type of installation a slot should be foreseen for ventilating the appliance.

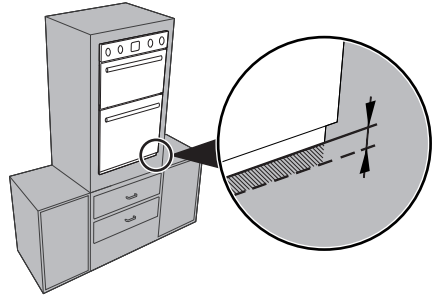

To be able to open the door completely, any unit protuberance should be at a distance of at least 1 cm from the oven.

## Appliance overall dimensions (mm)

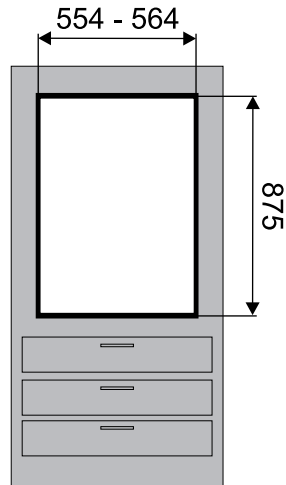
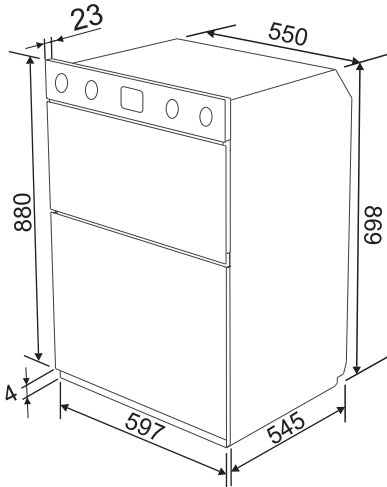



# Installation

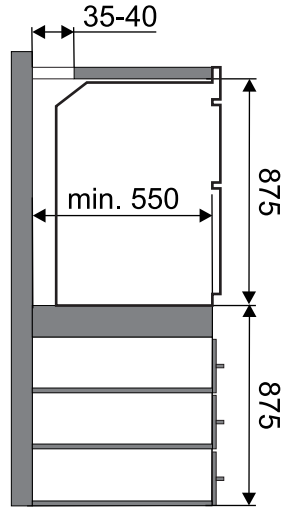
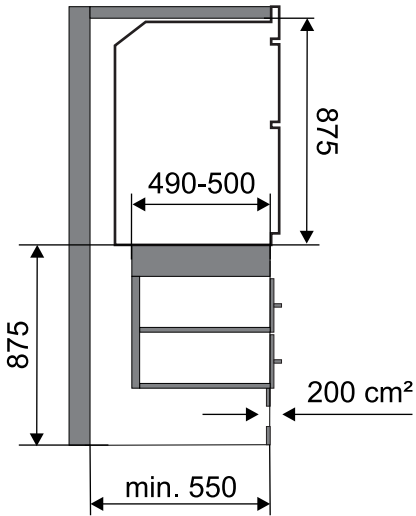

Create an opening with a total surface area of at least 200 cm<sup>2</sup> in the bottom front part of the unit.



Create an opening 35-40 mm deep in the top rear part of the unit.

