

USER MANUAL

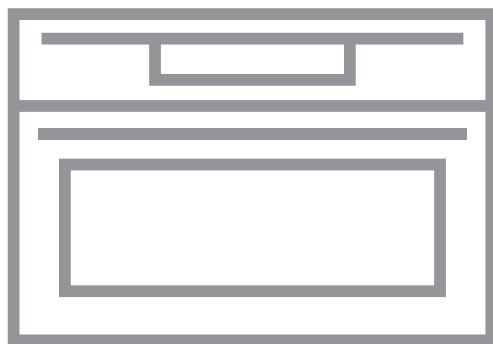

CONTENTS

1. SAFETY INFORMATION.....	3
2. CONDITIONS OF USE.....	5
3. SAFETY INSTRUCTIONS.....	5
4. PRODUCT DESCRIPTION.....	8
5. CONTROL PANEL.....	9
6. BEFORE FIRST USE.....	11
7. DAILY USE.....	11
8. MICROWAVE MODE.....	14
9. CLOCK FUNCTIONS.....	18
10. AUTOMATIC PROGRAMMES.....	20
11. USING THE ACCESSORIES.....	20
12. ADDITIONAL FUNCTIONS.....	21
13. HINTS AND TIPS.....	23
14. CARE AND CLEANING.....	39
15. TROUBLESHOOTING.....	40
16. INSTALLATION.....	42
17. ENERGY EFFICIENCY.....	45
18. WARRANTY	46

FOR PERFECT RESULTS

Thank you for choosing this AEG product. We have created it to give you impeccable performance for many years, with innovative technologies that help make life simpler features you might not find on ordinary appliances. Please spend a few minutes reading to get the very best from it.

Visit our website for:



Get usage advice, brochures, trouble shooter, service information:

www.aeg.com/webselfservice



Register your product for better service:

www.registeraeg.com

CUSTOMER CARE AND SERVICE

Always use original spare parts.

When contacting our Authorised Service Centre, ensure that you have the following data available: Model, PNC, Serial Number.

The information can be found on the rating plate.

 Warning / Caution-Safety information

 General information and tips

 Environmental information

Subject to change without notice.

1. SAFETY INFORMATION

Before the installation and use of the appliance, carefully read the supplied instructions. The manufacturer is not responsible for any injuries or damages that are the result of incorrect installation or usage. Always keep the instructions in a safe and accessible location for future reference.

1.1 Children and vulnerable people safety

- This appliance can be used by children aged from 8 years and above and persons with reduced physical, sensory or mental capabilities or lack of experience and knowledge if they have been given supervision or instruction concerning the use of the appliance in a safe way and understand the hazards involved.
- Do not let children play with the appliance.
- Keep all packaging away from children and dispose of it appropriately.
- Keep children and pets away from the appliance when it operates or when it cools down. Accessible parts are hot.
- If the appliance has a child safety device, this should be activated.
- Children shall not carry out cleaning and user maintenance of the appliance without supervision.
- Children aged 3 years and under must be kept away from this appliance when it is in operation at all times.

1.2 General Safety

- Only a qualified person must install this appliance and replace the cable.
- **WARNING:** The appliance and its accessible parts become hot during use. Care should be taken to avoid touching heating elements. Children less than 8 years of age shall be kept away unless continuously supervised.

- Always use oven gloves to remove or put in accessories or ovenware.
- Before carrying out any maintenance, disconnect the appliance from the power supply.
- Ensure that the appliance is switched off before replacing the lamp to avoid the possibility of electric shock.
- Do not use a steam cleaner to clean the appliance.
- Do not use harsh abrasive cleaners or sharp metal scrapers to clean the glass door since they can scratch the surface, which may result in shattering of the glass.
- If the mains power supply cable is damaged, it must be replaced by the manufacturer, its Authorised Service Centre or similarly qualified persons to avoid an electrical hazard.
- Do not activate the appliance when it is empty. Metal parts inside the cavity can create electric arcing.
- Metallic containers for food and beverages are not allowed during microwave cooking. This requirement is not applicable if the manufacturer specifies size and shape of metallic containers suitable for microwave cooking.
- If the door or door seals are damaged, the appliance must not be operated until it has been repaired by a qualified person.
- Only a qualified person can carry out any service or repair operation that involves the removal of a cover which gives protection against exposure to microwave energy.
- Do not heat liquids and other foods in sealed containers. They are liable to explode.
- Only use utensils that are suitable for use in microwave ovens.
- When heating food in plastic or paper containers, keep an eye on the appliance due to the possibility of ignition.
- The appliance is intended for heating food and beverages. Drying of food or clothing and heating of

warming pads, slippers, sponges, damp cloth and similar may lead to risk of injury, ignition or fire.

- If smoke is emitted, switch off or unplug the appliance and keep the door closed in order to stifle any flames.
- Microwave heating of beverages can result in delayed eruptive boiling. Care must be taken when handling the container.
- The contents of feeding bottles and baby food jars shall be stirred or shaken and the temperature checked before consumption, in order to avoid burns.
- Eggs in their shell and whole hard-boiled eggs should not be heated in the appliance since they may explode, even after microwave heating has ended.
- The appliance should be cleaned regularly and any food deposits removed.
- Failure to maintain the appliance in a clean condition could lead to deterioration of the surface that could adversely affect the life of the appliance and possibly result in a hazardous situation.

2. CONDITIONS OF USE

This appliance is intended to be used in household and similar applications such as:

- Farm houses
- By clients in serviced apartments, holiday apartments and other residential type environments.

3. SAFETY INSTRUCTIONS

3.1 Installation



WARNING!

Only a qualified person must install this appliance.

- Remove all the packaging.
- Do not install or use a damaged appliance.
- Follow the installation instruction supplied with the appliance.
- Always take care when moving the appliance as it is heavy. Always use safety gloves and enclosed footwear.
- Do not pull the appliance by the handle.

- Keep the minimum distance from the other appliances and units.
- Make sure that the appliance is installed below and adjacent safe structures.
- The sides of the appliance must stay adjacent to appliances or to units with the same height.

3.2 Electrical connection



WARNING!

Risk of fire and electrical shock.

- All electrical connections should be made by a qualified electrician.

- The appliance must be earthed.
- Make sure that the parameters on the rating plate are compatible with the electrical ratings of the mains power supply.
- Always use a correctly installed shockproof socket.
- Do not use multi-plug adapters and extension cables.
- Make sure not to cause damage to the mains plug and to the mains cable. Should the mains cable need to be replaced, this must be carried out by our Authorised Service Centre.
- Do not let mains cables touch or come near the appliance door, especially when the door is hot.
- The shock protection of live and insulated parts must be fastened in such a way that it cannot be removed without tools.
- Connect the mains plug to the mains socket only at the end of the installation. Make sure that there is access to the mains plug after the installation.
- If the mains socket is loose, do not connect the mains plug.
- Do not pull the mains cable to disconnect the appliance. Always pull the mains plug.
- Use only correct isolation devices: line protecting cut-outs, fuses (screw type fuses removed from the holder), earth leakage trips and contactors.
- The electrical installation must have an isolation device which lets you disconnect the appliance from the mains at all poles. The isolation device must have a contact opening width of minimum 3 mm.
- This appliance complies with the E.E.C. Directives.
- Deactivate the appliance after each use.
- Be careful when you open the appliance door while the appliance is in operation. Hot air can release.
- Do not operate the appliance with wet hands or when it has contact with water.
- Do not apply pressure on the open door.
- Do not use the appliance as a work surface or as a storage surface.
- Open the appliance door carefully. The use of ingredients with alcohol can cause a mixture of alcohol and air.
- Do not let sparks or open flames to come in contact with the appliance when you open the door.
- Do not put flammable products or items that are wet with flammable products in, near or on the appliance.
- Do not use microwave function to preheat the oven.



WARNING!

Risk of damage to the appliance.

- To prevent damage or discoloration to the enamel:
 - do not put aluminium foil directly on the bottom of cavity of the appliance.
 - do not put water directly into the hot appliance.
 - do not keep moist dishes and food in the appliance after you finish the cooking.
 - be careful when you remove or install the accessories.
- Discoloration of the enamel or stainless steel has no effect on the performance of the appliance.
- Use a deep pan for moist cakes. Fruit juices cause stains that can be permanent.
- This appliance is for cooking purposes only. It must not be used for other purposes, for example room heating.
- Always cook with the oven door closed.
- If the appliance is installed behind a furniture panel (e.g. a door) make sure the door is never closed when the appliance is in operation. Heat and moisture can build up behind a



WARNING!

Risk of injury, burns and electrical shock or explosion.

- Do not change the specification of this appliance.
- Make sure that the ventilation openings are not blocked.
- Do not let the appliance stay unattended during operation.

closed furniture panel and cause subsequent damage to the appliance, the housing unit or the floor. Do not close the furniture panel until the appliance has cooled down completely after use.

3.4 Care and cleaning



WARNING!

Risk of injury, fire, or damage to the appliance.

- Before maintenance, deactivate the appliance and disconnect the mains plug from the mains socket.
- Make sure the appliance is cold. There is the risk that the glass panels can break.
- Replace immediately the door glass panels when they are damaged. Contact the Authorised Service Centre.
- Be careful when you remove the door from the appliance. The door is heavy!
- Make sure the cavity and the door are wiped dry after each use. Steam produced during the operation of the appliance condensates on cavity walls and can cause corrosion.
- Clean regularly the appliance to prevent the deterioration of the surface material.
- Fat and food remaining in the appliance can cause fire and electric arcing when the microwave function operates.
- Clean the appliance with a moist soft cloth. Only use neutral detergents. Do not use any abrasive products,

abrasive cleaning pads, solvents or metal objects.

- If you use an oven spray, follow the safety instruction on it's packaging.
- Do not clean the catalytic enamel (if applicable) with any kind of detergent.

3.5 Internal light



WARNING!

Risk of electrical shock.

- The type of light bulb or halogen lamp used for this appliance is only for household appliances. Do not use it for house lighting.
- Before replacing the lamp, disconnect the appliance from the power supply.
- Only use lamps with the same specifications.

3.6 Disposal



WARNING!

Risk of injury or suffocation.

- Disconnect the appliance from the mains supply.
- Cut off the mains electrical cable close to the appliance and dispose of it.
- Remove the door catch to prevent children or pets from becoming trapped in the appliance.

3.7 Service

- To repair the appliance contact an Authorised Service Centre.
- Use original spare parts only.

4. PRODUCT DESCRIPTION

4.1 General overview

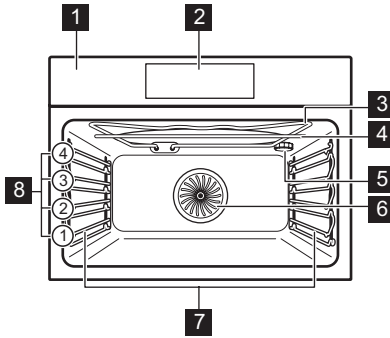

- 1 Control panel
- 2 Electronic programmer
- 3 Heating element
- 4 Microwave generator
- 5 Lamp
- 6 Fan
- 7 Shelf support, removable
- 8 Shelf positions

4.2 Accessories

Wire shelf

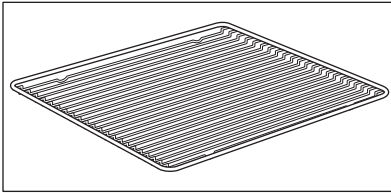

For cookware, cake tins, roasts.

Baking tray

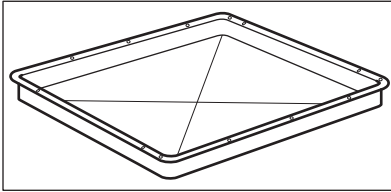

For cakes and biscuits.

Grill- / Roasting pan

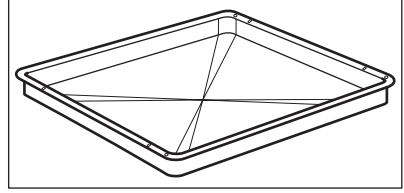





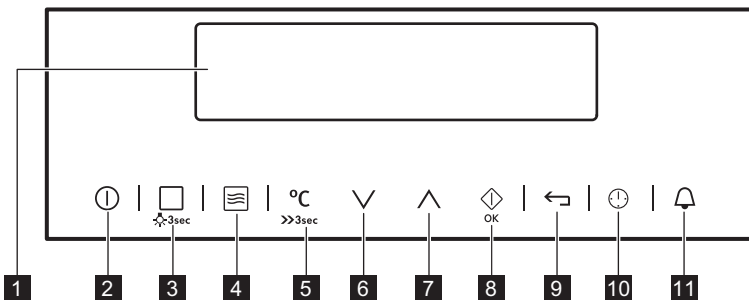

To bake and roast or as a pan to collect fat.



5. CONTROL PANEL

5.1 Electronic programmer



Use the sensor fields to operate the appliance.

Sensor field	Function	Comment
1	-	Display Shows the current settings of the appliance.
2	 ON / OFF	To activate and deactivate the appliance.
3	 Heating Functions or Assisted Cooking	Touch the sensor field once to choose a heating function or the menu: Assisted Cooking. Touch the sensor field again to switch between the menus: Heating Functions, Assisted Cooking. To activate or deactivate the light, touch the field for 3 seconds.
4	 Microwave function	To activate the Microwave function. You can use it when the appliance is deactivated. When you use the Microwave function with the function: Duration for more than 7 minutes and in Combi mode, the Microwave power cannot be more than 600 W.
5	 Temperature selection	To set the temperature or show the current temperature in the appliance. Touch the field for 3 seconds to activate or deactivate the function: Fast heat up.
6	 Down key	To move down in the menu.
7	 Up key	To move up in the menu.
8	 OK / Microwave Quick Start	To confirm the selection or settings. To activate the Microwave function. You can use it when the appliance is deactivated.





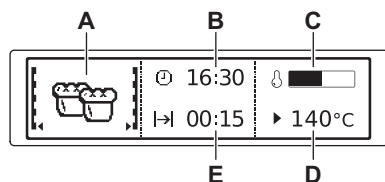





Sensor field	Function	Comment
9 	Back key	To go back one level in the menu. To show the main menu, touch the field for 3 seconds.
10 	Time and additional functions	To set different functions. When a heating function operates, touch the sensor field to set the timer or the functions: Function Lock, Favourites, Heat + Hold, Set + Go.
11 	Minute Minder	To set the function: Minute Minder.

5.2 Display



- A. Heating function or Microwave function
- B. Time of day
- C. Heat-up indicator
- D. Temperature or power of the microwave
- E. Duration time or end time of a function

Other indicators of the display:

Symbol	Function	Function
	Minute Minder	The function operates.
	Time of day	The display shows the current time.
	Duration	The display shows the necessary time for cooking.
	End Time	The display shows when the cooking time is complete.
	Temperature	The display shows the temperature.
	Time Indication	The display shows how long the heating function operates. Press  and  at the same time to reset the time.
	Heat-up Indicator	The display shows the temperature in the appliance.
	Fast Heat Up Indicator	The function is active. It decreases the heat up time.
	Weight Automatic	The display shows that the automatic weight system is active or that weight can be changed.

Symbol	Function
	Heat + Hold The function is active.

6. BEFORE FIRST USE



WARNING!
Refer to Safety chapters.

6.1 Initial Cleaning

Remove all accessories and removable shelf supports from the oven.



Refer to "Care and cleaning" chapter.

Clean the oven and the accessories before first use.
Put the accessories and the removable shelf supports back to their initial position.

6.2 First Connection

When you connect the appliance to the mains or after the power cut, you have to set the language, the display contrast, the display brightness and the time of the day.

1. Press  or  to set the value.
2. Press  to confirm.

7. DAILY USE



WARNING!
Refer to Safety chapters.

7.1 Navigating the menus

1. Activate the appliance.
2. Press  or  to select the menu option.





3. Press  to move to the submenu or accept the setting.

















At each point you can go back to the main menu with .

7.2 The menus in overview

Main menu







Sym- bol	Menu item	Application
	Heating Functions	Contains a list of heating functions.
	Assisted Cooking	Contains a list of automatic programmes.
	Basic Settings	Used to set the appliance configuration.
	Favourites	Contains a list of favourite cooking programmes created by the user.
	Specials	Contains a list of additional heating functions.

Submenu for: Basic Settings

Sym- bol	Submenu	Description
	Set Time of Day	Sets the current time on the clock.
	Time Indication	When ON, the display shows the current time when you deactivate the appliance.
	Fast heat up	When ON, the function decreases the heat-up time.
	Set + Go	To set a function and activate it later with a press of any symbol on the control panel.
	Heat + Hold	Keeps the prepared food warm for 30 minutes after a cooking cycle finished.
	Time Extension	Activates and deactivates the time extension function.
	Display Contrast	Adjusts the display contrast by degrees.
	Display Brightness	Adjusts the display brightness by degrees.
	Set Language	Sets the language for the display.
	Buzzer Volume	Adjusts the volume of press-tones and signals by degrees.
	Key Tones	Activates and deactivates the tone of the touch fields. It is not possible to deactivate the tone of the ON / OFF touch field.
	Alarm/Error Tones	Activates and deactivates the alarm tones.
	DEMO mode	Activation / deactivation code: 2468
	Service	Shows the software version and configuration.
	Factory Settings	Resets all settings to factory settings.







7.3 Heating Functions



Heating function	Application
 True Fan Cooking	To bake on up to two shelf positions at the same time and to dry food. Set the temperature 20 - 40 °C lower than for the function: Conventional Cooking.

Heating function	Application
 Pizza Setting	To bake food on one shelf position for a more intensive browning and a crispy bottom. Set the temperature 20 - 40 °C lower than for the function: Conventional Cooking.
 Conventional Cooking (Top / Bottom Heat)	To bake and roast food on one shelf position.
 Frozen Foods	To make convenience food like e.g. french fries, potato wedges or spring rolls crispy.
 Grilling	To grill flat food and to toast bread.
 Turbo Grilling	To bake cakes with crispy bottom and to preserve food.
 Bottom Heat	To bake cakes with crispy bottom and to preserve food.



 The lamp may automatically deactivate at a temperature below 60 °C during some oven functions.

7.4 Specials

Heating function	Application
 Keep Warm	To keep food warm.
 Plate Warming	To preheat plates for serving.
 Preserving	To make vegetable preserves such as pickles.
 Drying	To dry sliced fruit (e.g. apples, plums, peaches) and vegetables (e.g. tomatoes, zucchini, mushrooms).
 Dough Proving	For controlled rising of yeast dough before baking.
 Slow Cooking	To prepare tender, succulent roasts.

Heating function	Application
 Bread Baking	To bake bread.
 Defrost	This function can be used for defrosting frozen foods, such as vegetables and fruits. The defrosting time depends on the amount and size of the frozen food.

7.5 Activating a heating function

1. Activate the appliance.
2. Select the menu: Heating Functions.
3. Press  to confirm.
4. Select a heating function.
5. Press  to confirm.
6. Set the temperature.
7. Press  to confirm.

7.6 Heat-up indicator

When you activate a heating function, the bar on the display comes on. The bar shows that the temperature increases. When temperature is reached the buzzer sounds 3 times and the bar flashes and then disappears.

7.7 Fast Heat Up Indicator

This function decreases the heat-up time.

-  Do not put food in the oven when the Fast heat up function operates.

To activate the function, hold  for 3 seconds. The heat-up indicator alternates.

7.8 Residual heat

When you turn off the oven, the display shows the residual heat. You can use the heat to keep the food warm.

8. MICROWAVE MODE



WARNING!
Refer to Safety chapters.

8.1 Microwave Recommendations



CAUTION!
Do not let the oven operate when there is no food in it.

- Put the food into the oven without any packaging. The packaged ready meals can be put into the oven only when the packaging is microwave safe (check information on the packaging).
- Put the food on a plate on the bottom of the cavity when you use Microwave function.

Cooking

- Cook food covered. If you want to keep a crust cook food without a cover.
- Do not overcook the dishes by setting the power and time too high. The food can dry out, burn or cause fire.
- Do not use the oven to cook eggs or snails in their shells, because they can burst. Pierce the yolk of fried egg before reheating it.
- Pierce food with skin or peel with a fork several times before cooking.
- Cut vegetables into similar-sized pieces.
- Stir liquid dishes from time to time.
- Stir the food before serving.
- After you turn off the oven, take the food out and let it stand for a few minutes. Refer to the "Hints and tips" chapter.

Defrosting

- Put the frozen, unwrapped food on a small upturned plate with a container below it, or on a defrosting rack or plastic sieve so that the defrosting liquid can run off.
- Remove defrosted pieces subsequently.
- To cook fruit and vegetables without defrosting them first, you can use a higher microwave power.

8.2 Suitable cookware and materials

For the microwave use only suitable cookware and materials. Use below table as a reference.

Cookware / Material	Microwave			Heating Function + Microwave
	Defrosting	Heating	Cooking	
Ovenproof glass and porcelain with no metal components, e.g. heat-proof glass	✓	✓	✓	✓
Non-ovenproof glass and porcelain ¹⁾	✓	X	X	X
Glass and glass ceramic made of ovenproof / frost-proof material	✓	✓	✓	✓
Ceramic ²⁾ , earthenware ²⁾	✓	✓	✓	X
Ceramic, porcelain and earthenware with unglazed bottom or with small holes, e.g. on handles	X	X	X	X
Heat-resistant plastic up to 200 °C ³⁾	✓	✓	✓	X
Cardboard, paper	✓	X	X	X
Clingfilm	✓	X	X	X
Roasting film with microwave safe closure ³⁾	✓	✓	✓	X
Roasting dishes made of metal, e.g. enamel, cast iron	X	X	X	✓
Baking tins, black lacquer or silicon-coated ³⁾	X	X	X	✓
Baking tray	X	X	X	✓ ⁴⁾
Wire shelf	X	X	X	✓ ⁵⁾

Cookware / Material	Microwave			Heating Function + Microwave
	Defrosting	Heating	Cooking	
Cookware for microwave use, e.g. crisp pan	X	✓	✓	X

1) With no silver, gold, platinum or metal plating / decorations

2) Without quartz or metal components, or glazes which contain metals

3) You must follow the manufacturer's instructions about the maximum temperatures

4) Cook on one shelf level.

5) Cook on one shelf level.

8.3 Tips for the microwave

Result	Remedy
You cannot find details for the amount of food prepared.	Find details for similar type of food. Increase or shorten the length of the cooking time according to the following rule: double the amount - almost double the time, half the amount - half the time.
The food after cooking is too dry.	Set shorter cooking time or select lower microwave power and cover with material suitable for use in the microwave.
The food is still not defrosted, hot or cooked after the end of cooking time.	Set longer cooking time or select higher microwave power. Note that taller dishes generally need longer cooking time. Stir or turn food during cooking.
After the end of cooking time the food is overheated at the edges but is still not ready in the middle.	Next time select a lower power and a longer time. Stir liquids, such as soup, halfway through.



Other things to think about...



- Food items have different shapes and qualities. They are prepared in different quantities. Because of this, the necessary time and power for defrosting, heating or cooking can vary. As a rough guide: **double the quantity - almost double the time.**
- The microwave creates the heat directly in the food. Because of this, all places cannot be heated at the same time. You must stir or turn the heated dishes, especially when preparing larger quantities of food.
- The **standing time** is given in the tables. Let the food stand, in the appliance or outside it, so that the heat is distributed more evenly.
- Adjust the power level according to food quantity. Using high power level with small amount of food can burn the food or generate arcing when you use the accessories.
- You get better results for rice if you use flat, wide dishes.



8.4 Microwave functions

Functions	Description
Microwave	Creates the heat directly in the food. Use it to heat pre-prepared meals and drinks, to defrost meat or fruit, and to cook vegetables and fish.
Combi	Use it to operate the heating function and the microwave mode together. Use it to cook food in a shorter time and brown it simultaneously. The maximum power for this function is 600 W
Quick Start	Use it to activate the Microwave function with one touch of the symbol  with the maximum microwave power. Operating time: 30 seconds.

8.5 Setting the Microwave function

1. Activate the appliance.
2. Touch  to activate the Microwave function.
3. Touch . The function: Duration is set to 30 seconds and the microwaves starts to operate.



 Each touch of  adds 30 seconds to the time of the function: Duration.

 If you do not touch , the appliance deactivates after 20 seconds.



4. Touch  to set the function: Duration. Refer to "Setting the clock functions".



 When the time of the function: Duration is longer than 7 minutes the Microwave power is decreased to 600 W.

 The maximum setting of the time for the function: Duration is 90 minutes.

 You can change the microwave power (touch  and then ∇ or \blacktriangle) and the function: Duration  any time when the Microwave function operates.

5. When the set time ends, an acoustic signal sounds for 2 minutes. The Microwave function deactivates automatically. Touch any symbol to stop the acoustic signal.

 To deactivate the Microwave function, touch .

 If you touch  or open the door, the function stops. To start it again, touch .



8.6 Setting the Combi function

1. Activate a heating function. Refer to "Activating a heating function".
2. Touch  and do the same steps as when you set the Microwave function.

 For some functions the microwave will start as soon as the set temperature is reached.

Functions not available for the Combi function: Favourites, End Time, Set + Go, Heat + Hold.

8.7 Setting the Quick Start function

1. If necessary, touch  to deactivate the appliance.
2. Touch  to activate the Quick Start function.

Each touch of  adds 30 seconds to the Duration time.



You can change the microwave power (refer to "Setting the Microwave function").

3. Touch  to set the time for the function: Duration. Refer to "Setting the clock functions".





8.8 Examples of cooking applications for power settings



The data in the table is for guidance only.

Power setting	Use
<ul style="list-style-type: none"> • 1000 Watt • 900 Watt • 800 Watt • 700 Watt 	Heating liquids Searing at the start of the cooking process Cooking vegetables
<ul style="list-style-type: none"> • 600 Watt • 500 Watt 	Defrosting and heating frozen meals Heating one-plate meals Simmering stews Cooking egg dishes
<ul style="list-style-type: none"> • 400 Watt • 300 Watt 	Continuing to cook meals Cooking delicate food Heating baby food Simmering rice Heating delicate food Melting cheese, chocolate, butter
<ul style="list-style-type: none"> • 200 Watt • 100 Watt 	Defrosting meat, fish Defrosting cheese, cream, butter Defrosting fruit and cakes Defrosting bread

9. CLOCK FUNCTIONS

9.1 Clock functions table

Clock function	Application
 Minute Minder	<p>To set a countdown (max. 2 h 30 min). This function has no effect on the operation of the appliance. You can also activate it when the appliance is deactivated.</p> <p>Use  to activate the function. Press  or  to set the minutes and  to start.</p>

Clock function		Application
	Duration	To set the length of an operation (max. 23 h 59 min).
	End Time	To set the switch-off time for a heating function (max. 23 h 59 min).

If you set the time for a clock function, the time starts to count down after 5 seconds.







If you use the clock functions: Duration, End Time, the appliance deactivates the heating elements after 90 % of the set time. The appliance uses the residual heat to continue the cooking process until the time ends (3 - 20 minutes).

9.2 Setting the clock functions



Before you use the functions: Duration, End Time, you must set a heating function and temperature first. The appliance deactivates automatically. You can use the functions: Duration and End Time at the same time if you want to automatically activate and deactivate the appliance on a given time later.

1. Set a heating function.
2. Press  again and again until the display shows the necessary clock function and the related symbol.
3. Press  or  to set the necessary time.
4. Press  to confirm.
When the time ends, an acoustic signal sounds. The appliance deactivates. The display shows a message.
5. Press any symbol to stop the signal.



9.3 Heat + Hold

Conditions for the function:

- The set temperature is more than 80 °C.
- The function: Duration is set.

The function: Heat + Hold keeps prepared food warm at 80 °C for 30 minutes. It activates after the baking or roasting procedure ends.

You can activate or deactivate the function in the menu: Basic Settings.



1. Activate the appliance.
2. Select the heating function.
3. Set the temperature above 80 °C.
4. Press  again and again until the display shows: Heat + Hold.
5. Press  to confirm.
When the function ends, an acoustic signal sounds.
The function stays on if you change the heating functions.

9.4 Time Extension

The function: Time Extension makes the heating function continue after the end of Duration.



Applicable to all heating functions with Duration or Weight Automatic.

1. When the cooking time ends, an acoustic signal sounds. Press any symbol.
The display shows the message.
2. Press  to activate or  to cancel.
3. Set the length of the function.
4. Press .

10. AUTOMATIC PROGRAMMES



WARNING!
Refer to Safety chapters.



10.1 Recipes online



You can find the recipes for the automatic programmes specified for this appliance on our website. To find the proper Recipe Book check the PNC number on the rating plate on the front frame of the appliance cavity.

10.2 Assisted Cooking with Recipe Automatic

This appliance has a set of recipes you can use. The recipes are fixed and you cannot change them.







1. Activate the appliance.
2. Select the menu: Assisted Cooking.
Press  to confirm.
3. Select the category and dish. Press  to confirm.
4. Select a recipe. Press  to confirm.



When you use the function: Manual, the appliance uses the automatic settings. You can change them as with other functions.

10.3 Assisted Cooking with Weight Automatic

This function automatically calculates the roasting time. To use it, it is necessary to input the food weight.

1. Activate the appliance.
2. Select the menu: Assisted Cooking.
Press  to confirm.
3. Select the category and dish. Press  to confirm.
4. Touch  or  to set the food weight. Press  to confirm.
The automatic programme starts.
5. You can change the weight at any time. Press  or  to change the weight.
6. When the time ends, an acoustic signal sounds. Press any symbol to deactivate the signal.



With some programmes turn over the food after 30 minutes. The display shows a reminder.

11. USING THE ACCESSORIES



WARNING!
Refer to Safety chapters.

11.1 Inserting the accessories

Use only suitable cookware and material.



WARNING!
Refer to "Microwave mode" chapter.

Wire shelf:

Push the shelf between the guide bars of the shelf support and make sure that the feet point down.

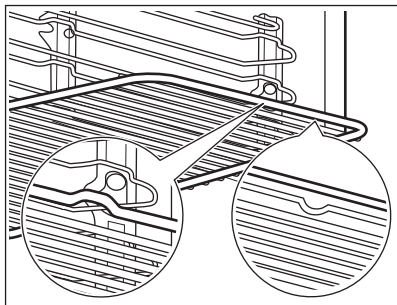

Baking tray / Deep pan:

Push the baking tray / deep pan between the guide bars of the shelf support.

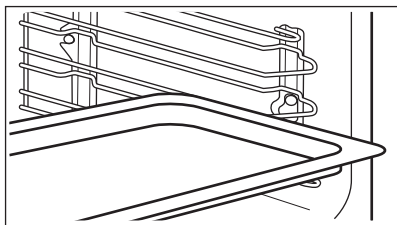

Wire shelf and baking tray / deep pan together:

Push the baking tray / deep pan between the guide bars of the shelf support and the wire shelf on the guide bars above.

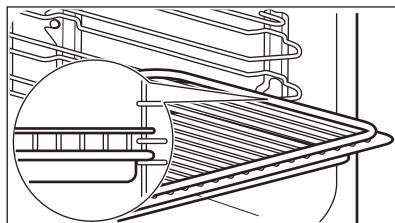

Small indentation at the top increase safety. The indentations are also anti-tip devices. The high rim around the shelf prevents cookware from slipping of the shelf.

12. ADDITIONAL FUNCTIONS



12.1 Favourites

You can save your favourite settings, such as duration, temperature or heating function. They are available in the menu: Favourites. You can save 20 programmes.



You cannot save Microwave and microwave combi functions as favourite programmes.

Saving a programme

1. Activate the appliance.
2. Set a heating function or an automatic programme.
3. Touch  again and again until the display shows: SAVE.
4. Press  to confirm. The display shows the first free memory position.
5. Press  to confirm.
6. Enter the name of the programme. The first letter flashes.



7. Touch  or  to change the letter.

8. Press .

The next letter flashes.



9. Do step 7 again as necessary.

10. Press and hold  to save.

You can overwrite a memory position. When the display shows the first free memory position, touch  or  and press  to overwrite an existing programme.



You can change the name of a programme in the menu: Edit Programme Name.

Activating the programme

1. Activate the appliance.
2. Select the menu: Favourites.
3. Press .
4. Select your favourite programme name.
5. Press .



12.2 Using the Child Lock



When the Child Lock is on, the appliance cannot be activated accidentally.

1. Touch  to activate the display.
2. Touch  and  at the same time until the display shows a message. To deactivate the Child Lock function repeat step 2.

12.3 Function Lock

This function prevents an accidental change of the heating function. You can activate it only when the appliance operates.



1. Activate the appliance.
2. Set a heating function or setting.
3. Press  again and again until the display shows: Function Lock.
4. Press  to confirm.

To deactivate the function, press . The display shows a message. Press  again and then  to confirm.

 When you deactivate the appliance, the function also deactivates.

12.4 Set + Go

The function lets you set a heating function (or a programme) and use it later with one press of any symbol.

1. Activate the appliance.
2. Set a heating function.
3. Press  again and again until the display shows: Duration.
4. Set the time.
5. Press  again and again until the display shows: Set + Go.
6. Press  to confirm.

Press any symbol (except for ) to start the function: Set + Go. The set heating function starts.

When the heating function ends, an acoustic signal sounds.



- Function Lock is on when the heating function operates.
- The menu: Basic Settings lets you activate and deactivate the function: Set + Go.

12.5 Automatic Switch-off

For safety reasons the appliance turns off automatically after some time if a heating function operates and you do not change any settings.

Temperature (°C)	Switch-off time (h)
30 - 115	12.5
120 - 195	8.5
200 - 230	5.5



The Automatic switch-off does not work with the functions: Light, Duration, End Time.

12.6 Brightness of the display

There are two modes of display brightness:

- Night brightness - when the appliance is deactivated, the brightness of the display is lower between 10 PM and 6 AM.
- Day brightness:
 - when the appliance is activated.
 - if you touch a symbol during the night brightness (apart from ON / OFF), the display goes back to the day brightness mode for the next 10 seconds.
 - if the appliance is deactivated and you set the function: Minute Minder. When the function ends, the display goes back to the night brightness.

12.7 Cooling fan

When the oven operates, the cooling fan turns on automatically to keep the surfaces of the oven cool. If you turn off

the oven, the cooling fan can continue to operate until the oven cools down.

13. HINTS AND TIPS



WARNING!
Refer to Safety chapters.



The temperature and baking times in the tables are guidelines only. They depend on the recipes and the quality and quantity of the ingredients used.

13.1 Advice for special heating functions of the oven

Keep Warm

Use this function if you want to keep food warm.

The temperature regulates itself automatically to 80 °C.

Plate Warming

For warming plates and dishes.

Distribute plates and dishes evenly on the wire shelf. Move stacks around after half of the warming time (swap top and bottom).

The automatic temperature is 70 °C.

Recommended shelf position: 3.

Dough Proving

You can use this automatic function with any recipe for yeast dough you like. It gives you a good atmosphere for rising. Put the dough into a dish that is big enough for rising and cover it with a wet towel or plastic foil. Insert a wire shelf on the first shelf position and put the dish in. Close the door and set the function: Dough Proving. Set the necessary time.

13.2 Baking

- Your oven may bake or roast differently to the oven you had before. Adapt your usual settings such as temperature, cooking time and shelf position to the values in the tables.
- Use the lower temperature the first time.
- If you cannot find the settings for a special recipe, look for the similar one.
- You can extend baking times by 10 – 15 minutes if you bake cakes on more than one shelf position.
- Cakes and pastries at different heights do not always brown equally at first. If this occurs, do not change the temperature setting. The differences equalize during the baking procedure.
- Trays in the oven can twist during baking. When the trays become cold again, the distortions disappear.

13.3 Tips on baking

Baking results	Possible cause	Remedy
The bottom of the cake is not browned sufficiently.	The shelf position is incorrect.	Put the cake on a lower shelf.
The cake sinks and becomes soggy, lumpy or streaky.	The oven temperature is too high.	The next time you bake, set a slightly lower oven temperature.

Baking results	Possible cause	Remedy
The cake sinks and becomes soggy, lumpy or streaky.	The baking time is too short.	Set a longer baking time. You cannot decrease baking times by setting higher temperatures.
The cake sinks and becomes soggy, lumpy or streaky.	There is too much liquid in the mixture.	Use less liquid. Be careful with mixing times, especially if you use a mixing machine.
The cake is too dry.	The oven temperature is too low.	The next time you bake, set a higher oven temperature.
The cake is too dry.	The baking time is too long.	The next time you bake, set a shorter baking time.
The cake browns unevenly.	The oven temperature is too high and the baking time is too short.	Set a lower oven temperature and a longer baking time.
The cake browns unevenly.	The mixture is unevenly distributed.	Spread the mixture evenly on the baking tray.
The cake is not ready in the baking time given.	The oven temperature is too low.	The next time you bake, set a slightly higher oven temperature.

13.4 Baking on one oven level

Baking in tins

Food	Function	Temperature (°C)	Time (min)	Shelf position
Ring cake or brioche	True Fan Cooking	150 - 160	50 - 70	2
Madeira cake / Fruit cakes	True Fan Cooking	140 - 160	70 - 90	2
Sponge cake / Sponge cake	True Fan Cooking	140 - 150	35 - 50	2
Sponge cake / Sponge cake	Conventional Cooking	160	35 - 50	2
Flan base - short pastry ¹⁾	True Fan Cooking	170 - 180	10 - 25	2
Flan base - sponge mixture	True Fan Cooking	150 - 170	20 - 25	2
Apple pie / Apple pie (2 tins Ø 20 cm, diagonally off set)	True Fan Cooking	160	70 - 90	2

Food	Function	Temperature (°C)	Time (min)	Shelf position
Apple pie / Apple pie (2 tins Ø 20 cm, diagonally off set)	Conventional Cooking	180	70 - 90	1
Cheesecake, tray ²⁾	Conventional Cooking	160 - 170	60 - 90	1

1) Preheat the oven.

2) Use a deep pan.

Cakes / pastries / breads on baking trays

Food	Function	Temperature (°C)	Time (min)	Shelf position
Plaited bread / bread crown	Conventional Cooking	170 - 190	30 - 40	2
Christmas stollen ¹⁾	Conventional Cooking	160 - 180	50 - 70	2
Bread (rye bread) ¹⁾	Conventional Cooking			2
first		230	20	
then		160 - 180	30 - 60	
Cream puffs / Eclairs ¹⁾	Conventional Cooking	190 - 210	20 - 35	2
Swiss Roll ¹⁾	Conventional Cooking	180 - 200	10 - 20	2
Cake with crumble topping (dry)	True Fan Cooking	150 - 160	20 - 40	3
Buttered almond cake / sugar cakes ¹⁾	Conventional Cooking	190 - 210	20 - 30	2
Fruit flans (made with yeast dough / sponge mixture) ²⁾	True Fan Cooking	150 - 160	35 - 55	3
Fruit flans (made with yeast dough / sponge mixture) ²⁾	Conventional Cooking	170	35 - 55	1
Fruit flans made with short pastry	True Fan Cooking	160 - 170	40 - 80	3

Food	Function	Temperature (°C)	Time (min)	Shelf position
Yeast cakes with delicate toppings (e.g. quark, cream, custard) ¹⁾	Conventional Cooking	160 - 180	40 - 80	2

1) Preheat the oven.

2) Use a deep pan.

Biscuits

Food	Function	Temperature (°C)	Time (min)	Shelf position
Short pastry biscuits	True Fan Cooking	150 - 160	10 - 20	3
Short bread / Short bread / Pastry Stripes	True Fan Cooking	140	20 - 35	3
Short bread / Short bread / Pastry Stripes ¹⁾	Conventional Cooking	160	20 - 30	2
Biscuits made with sponge mixture	True Fan Cooking	150 - 160	15 - 20	2
Pastries made with egg white, meringues	True Fan Cooking	80 - 100	120 - 150	1
Macaroons	True Fan Cooking	100 - 120	30 - 50	3
Biscuits made with yeast dough	True Fan Cooking	150 - 160	20 - 40	3
Puff pastries ¹⁾	True Fan Cooking	170 - 180	20 - 30	3
Rolls ¹⁾	Conventional Cooking	190 - 210	10 - 25	2
Small cakes / Small cakes ¹⁾	True Fan Cooking	160	20 - 35	3
Small cakes / Small cakes ¹⁾	Conventional Cooking	170	20 - 35	2

1) Preheat the oven.

13.5 Bakes and gratins

Food	Function	Temperature (°C)	Time (min)	Shelf position
Pasta bake	Conventional Cooking	180 - 200	45 - 60	1
Lasagne	Conventional Cooking	180 - 200	25 - 40	1
Vegetables au gratin ¹⁾	Turbo Grilling	210 - 230	10 - 20	1
Baguettes topped with melted cheese	True Fan Cooking	160 - 170	15 - 30	1
Sweet bakes	Conventional Cooking	180 - 200	40 - 60	1
Fish bakes	Conventional Cooking	180 - 200	30 - 60	1
Stuffed vegetables	True Fan Cooking	160 - 170	30 - 60	1

¹⁾ Preheat the oven.

13.6 Multilevel baking

Use the function: True Fan Cooking.

Cakes / pastries / breads on baking trays

Food	Temperature (°C)	Time (min)	Shelf position
Cream puffs / Eclairs ¹⁾	160 - 180	25 - 45	1 / 3
Dry streusel cake	150 - 160	30 - 45	1 / 3

¹⁾ Preheat the oven.

Biscuits / small cakes / pastries / rolls

Food	Temperature (°C)	Time (min)	Shelf position
Short pastry biscuits	150 - 160	20 - 40	1 / 3
Short bread / Short bread / Pastry Stripes	140	25 - 45	1 / 3
Biscuits made with sponge mixture	160 - 170	25 - 40	1 / 3

Food	Temperature (°C)	Time (min)	Shelf position
Pastries made with egg white, meringues	80 - 100	130 - 170	1 / 3
Macaroons	100 - 120	40 - 80	1 / 3
Biscuits made with yeast dough	160 - 170	30 - 60	1 / 3

13.7 Slow Cooking

Use this function to prepare lean, tender pieces of meat and fish. This function is not applicable to such recipes as pot roast or fatty roast pork.



WARNING!

Refer to "Hints and tips" chapter.

In the first 10 minutes you can set an oven temperature between 80 °C and 150 °C. The default is 90 °C. After the temperature is set, the oven continues to

cook at 80 °C. Do not use this function for poultry.



Always cook without a lid when you use this function.

1. Sear the meat in a pan on the hob on a very high setting for 1 - 2 minutes on each side.
2. Put the meat together with the hot roasting pan on the wire shelf in the oven.
3. Select the function: Slow Cooking.

Food	Quantity (kg)	Temperature (°C)	Time (min)	Shelf position
Roast beef	1 - 1.5	150	120 - 150	1
Fillet of beef	1 - 1.5	150	90 - 110	1
Roast veal	1 - 1.5	150	120 - 150	1
Steak	0.2 - 0.3	120	20 - 40	1

13.8 Pizza Setting

Food	Temperature (°C)	Time (min)	Shelf position
Pizza (thin crust) ¹⁾	200 - 230	15 - 20	3
Pizza (with a lot of topping) ²⁾	180 - 200	20 - 30	3
Tarts	180 - 200	40 - 55	3
Spinach flan	160 - 180	45 - 60	3
Quiche Lorraine (Savoury flan)	170 - 190	45 - 55	3

Food	Temperature (°C)	Time (min)	Shelf position
Swiss Flan	170 - 190	45 - 55	3
Cheesecake	140 - 160	60 - 90	3
Apple cake, covered	150 - 170	50 - 60	3
Vegetable pie	160 - 180	50 - 60	3
Unleavened bread ¹⁾	230	10 - 20	3
Puff pastry flan ¹⁾	160 - 180	45 - 55	3
Flammekuchen ¹⁾	230	12 - 20	3
Piroggen (Russian version of calzone) ¹⁾	180 - 200	15 - 25	3

1) Preheat the oven.

2) Use a deep pan.

13.9 Roasting

- Use heat-resistant ovenware to roast. Refer to the instructions of the ovenware manufacturer.
- You can roast large roasting joints directly in the deep pan or on the wire shelf above the deep pan.
- Put some liquid in the deep pan to prevent the meat juices or fat from burning on its surface.
- All types of meat that can be browned or have crackling can be roasted in the roasting tin without the lid.
- If necessary, turn the roast after 1/2 to 2/3 of the cooking time.
- To keep meat more succulent:
 - roast lean meat in the roasting tin with the lid or use roasting bag.
 - roast meat and fish in pieces weighting minimum 1 kg.
 - baste large roasts and poultry with their juices several times during roasting.

13.10 Roasting tables

Beef

Food	Function	Quantity (kg)	Power (Watts)	Temperature (°C)	Time (min)	Shelf position
Pot roast	Conventional Cooking	1 - 1.5	200	230	60 - 80	1

Pork

Food	Function	Quantity (kg)	Power (Watts)	Temperature (°C)	Time (min)	Shelf position
Shoulder, neck, ham joint	Turbo Grilling	1 - 1.5	200	160 - 180	50 - 70	1

Food	Function	Quantity (kg)	Power (Watts)	Temperature (°C)	Time (min)	Shelf position
Meat loaf	Turbo Grilling	0.75 - 1	200	160 - 170	35 - 50	1
Pork knuckle (pre-cooked)	Turbo Grilling	0.75 - 1	200	150 - 170	60 - 75	1

Veal

Food	Function	Quantity (kg)	Power (Watts)	Temperature (°C)	Time (min)	Shelf position
Roast veal	Turbo Grilling	1	200	160 - 180	50 - 70	1
Knuckle of veal	Turbo Grilling	1.5 - 2	200	160 - 180	75 - 100	1

Lamb

Food	Function	Quantity (kg)	Power (Watts)	Temperature (°C)	Time (min)	Shelf position
Leg of lamb, roast lamb	Turbo Grilling	1 - 1.5	200	150 - 170	50 - 70	1

Poultry

Food	Function	Quantity (kg)	Power (Watts)	Temperature (°C)	Time (min)	Shelf position
Poultry portions	Turbo Grilling	0.2 - 0.25 each	200	200 - 220	20 - 35	1
Chicken half	Turbo Grilling	0.4 - 0.5 each	200	190 - 210	25 - 40	1
Chicken poulard	Turbo Grilling	1 - 1.5	200	190 - 210	30 - 45	1
Duck	Turbo Grilling	1.5 - 2	200	180 - 200	45 - 65	1

Fish (steamed)

Food	Function	Quantity (kg)	Power (Watts)	Temperature (°C)	Time (min)	Shelf position
Whole fish	Conventional Cooking	1 - 1.5	200	210 - 220	30 - 45	1

Dishes

Food	Function	Quantity (kg)	Power (Watts)	Temperature (°C)	Time (min)	Shelf position
Dishes sweet	True Fan Cooking	-	200	160 - 180	20 - 35	1
Savoury dishes with cooked ingredients (noodles, vegetables)	True Fan Cooking	-	400 - 600	160 - 180	20 - 45	1
Savoury dishes with raw ingredients (potatoes, vegetables)	True Fan Cooking	-	400 - 600	160 - 180	30 - 45	2

13.11 Grilling

- Always grill with the maximum temperature setting.
- Set the shelf into the shelf position as recommended in the grilling table.
- Always set the pan to collect the fat into the first shelf position.

- Grill only flat pieces of meat or fish.
- Always preheat the empty oven with the grill functions for 5 minutes.

CAUTION!

Always grill with the oven door closed.

Grilling

Food	Temperature (°C)	Time (min)		Shelf position
		1st side	2nd side	
Roast beef, medium	210 - 230	30 - 40	30 - 40	1
Filet of beef, medium	230	20 - 30	20 - 30	1
Back of pork	210 - 230	30 - 40	30 - 40	1

Food	Temperature (°C)	Time (min)		Shelf position
		1st side	2nd side	
Back of veal	210 - 230	30 - 40	30 - 40	1
Back of lamb	210 - 230	25 - 35	20 - 35	1
Whole Fish, 500 - 1000 g	210 - 230	15 - 30	15 - 30	1

Fast Grilling

Food	Time (min)		Shelf position
	1st side	2nd side	
Burgers / Burgers	9 - 13	8 - 10	3
Pork fillet	10 - 12	6 - 10	2
Sausages	10 - 12	6 - 8	3
Fillet steaks / veal steaks	7 - 10	6 - 8	3
Toast / Toast	1 - 3	1 - 3	3
Toast with topping	6 - 8	-	2

13.12 Frozen foods

- Remove the food packaging. Put the food on a plate.

- Do not cover it with a bowl or a plate. This can extend the defrost time.

Food	Temperature (°C)	Time (min)	Shelf position
Pizza, frozen	200 - 220	15 - 25	3
Pizza American, frozen	190 - 210	20 - 25	3
Pizza, chilled	210 - 230	13 - 25	3
Pizza Snacks, frozen	180 - 200	15 - 30	3
French Fries, thin ¹⁾	210 - 230	20 - 30	3
French Fries, thick ¹⁾	210 - 230	25 - 35	3
Wedges / Croquettes ¹⁾	210 - 230	20 - 35	3
Hash Browns	210 - 230	20 - 30	3
Lasagne / Cannelloni, fresh	170 - 190	35 - 45	2

Food	Temperature (°C)	Time (min)	Shelf position
Lasagne / Cannelloni, frozen	160 - 180	40 - 60	2
Chicken Wings	190 - 210	20 - 30	3

1) Turn 2 or 3 times during roasting.

Frozen Ready Meals Table

Food	Function	Temperature (°C)	Time (min)	Shelf position
Frozen pizza ¹⁾	Conventional Cooking	as per manufacturer's instructions	as per manufacturer's instructions	2
Chips ²⁾ (300 - 600 g)	Conventional Cooking or Turbo Grilling	200 - 220	as per manufacturer's instructions	2
Baguettes ³⁾	Conventional Cooking	as per manufacturer's instructions	as per manufacturer's instructions	2
Fruit cake	Conventional Cooking	as per manufacturer's instructions	as per manufacturer's instructions	2

1) Preheat the oven.

2) Turn 2 or 3 times during cooking.

3) Preheat the oven.

13.13 Defrost

- Remove the food packaging and put the food on a plate.
- Use the first shelf position from the bottom.

- Do not cover the food with a bowl or a plate, as this can extend the defrost time.

Food	Quantity	Defrosting time (min)	Further defrosting time (min)	Comments
Chicken	1 kg	100 - 140	20 - 30	Put the chicken on an upturned saucer in a big plate. Turn halfway through.
Meat	1 kg	100 - 140	20 - 30	Turn halfway through.
Meat	500 g	90 - 120	20 - 30	Turn halfway through.
Trout	150 g	25 - 35	10 - 15	-

Food	Quantity	Defrosting time (min)	Further defrosting time (min)	Comments
Strawberries	300 g	30 - 40	10 - 20	-
Butter	250 g	30 - 40	10 - 15	-
Cream	2 x 200 g	80 - 100	10 - 15	Whip the cream when still slightly frozen in places.
Gateau	1.4 kg	60	60	-

13.14 Preserving

- Use only preserve jars of the same dimensions available on the market.
- Do not use jars with twist-off and bayonet type lids or metal tins.
- Use the first shelf from the bottom for this function.
- Put no more than six one-litre preserve jars on the baking tray.
- Fill the jars equally and close with a clamp.
- The jars cannot touch each other.
- Put approximately 1/2 litre of water into the baking tray to give sufficient moisture in the oven.
- When the liquid in the jars starts to simmer (after approximately 35 - 60 minutes with one-litre jars), stop the oven or decrease the temperature to 100 °C (see the table).

Soft fruit

Food	Temperature (°C)	Cooking time until simmering (min)	Continue to cook at 100 °C (min)
Strawberries / Blueberries / Raspberries / Ripe gooseberries	160 - 170	35 - 45	-

Stone fruit

Food	Temperature (°C)	Cooking time until simmering (min)	Continue to cook at 100 °C (min)
Pears / Quinces / Plums	160 - 170	35 - 45	10 - 15

Vegetables

Food	Temperature (°C)	Cooking time until simmering (min)	Continue to cook at 100 °C (min)
Carrots ¹⁾	160 - 170	50 - 60	5 - 10
Cucumbers	160 - 170	50 - 60	-
Mixed pickles	160 - 170	50 - 60	5 - 10

Food	Temperature (°C)	Cooking time until simmering (min)	Continue to cook at 100 °C (min)
Kohlrabi / Peas / Asparagus	160 - 170	50 - 60	15 - 20

1) Leave standing in the oven after it is deactivated.

13.15 Drying

Food	Temperature (°C)	Time (h)	Shelf position
Beans	60 - 70	6 - 8	3
Peppers	60 - 70	5 - 6	3
Vegetables for soup	60 - 70	5 - 6	3
Mushrooms	50 - 60	6 - 8	3
Herbs	40 - 50	2 - 3	3
Plums	60 - 70	8 - 10	3
Apricots	60 - 70	8 - 10	3
Apple slices	60 - 70	6 - 8	3
Pears	60 - 70	6 - 9	3

13.16 Bread Baking

Preheating is not recommended.

Food	Temperature (°C)	Time (min)	Shelf position
White Bread	180 - 200	40 - 60	2
Baguette	200 - 220	35 - 45	2
Brioche	160 - 180	40 - 60	2
Ciabatta	200 - 220	35 - 45	2
Rye Bread	180 - 200	50 - 70	2
Dark Bread	180 - 200	50 - 70	2
All Grain bread	170 - 190	60 - 90	2

13.17 Microwave cooking

Place the plate with the food on the bottom of the cavity and turn it halfway through the cooking time.

Stir the food halfway through the cooking or defrosting time.

Put the spoon to the bottle or glass when heating drinks to ensure better heat distribution.

If you cannot find desired recipe, refer to the similar type of food in the tables.

Cover the food for cooking and reheating.

Tips for the Microwave

Cooking/Defrosting results	Possible cause	Remedy
The food is too dry.	The power was too high. The time was too long. The food was not covered.	Next time select a lower power and a longer time.
The food is still not defrosted, hot or cooked after the end of cooking time.	The time was too short.	Set a longer time. Do not increase the Microwave Power.
The food is overheated at the edges but is still not ready in the middle.	The power was too high. The food was not turned during the cooking cycle.	Next time select a lower power and a longer time.

Defrosting meat

Food	Power (Watts)	Time (min)	Standing time (min)
Steak (0.2 kg)	100	5 - 7	5 - 10
Minced meat (0.5 kg)	100	10 - 15	5 - 10

Defrosting poultry

Food	Power (Watts)	Time (min)	Standing time (min)
Chicken (1 kg)	100	25 - 30	10 - 20
Chicken breast (0.15 kg)	100	3 - 5	10 - 15
Chicken legs (0.15 kg)	100	3 - 5	10 - 15

Defrosting fish

Food	Power (Watts)	Time (min)	Standing time (min)
Whole Fish (0.5 kg)	100	10 - 15	5 - 10
Fish fillets (0.5 kg)	100	12 - 15	5 - 10

Defrosting dairy products

Food	Power (Watts)	Time (min)	Standing time (min)
Butter (0.25 kg)	100	3 - 4	5 - 10
Grated cheese (0.2 kg)	100	2 - 3	10 - 15

Defrosting cakes / pastries

Food	Power (Watts)	Time (min)	Standing time (min)
Yeast cake (1 piece)	200	2 - 3	15 - 20
Cheesecake (1 piece)	100	2 - 4	15 - 20
Dry cake (e.g. Pound cake) (1 piece)	200	2 - 4	15 - 20
Bread (1 kg)	200	15 - 20	5 - 10
Sliced bread (0,2 kg)	200	3 - 5	5 - 10
Bread rolls (4 pieces)	200	2 - 4	2 - 5

Defrosting fruit

Food	Power (Watts)	Time (min)	Standing time (min)
Fruit (0.25 kg)	100	5 - 10	10 - 15

Reheating

Food	Power (Watts)	Time (min)	Standing time (min)
Baby food in jars (0.2 kg)	300	1 - 2	-
Baby milk (180 ml); Put spoon into the bottle	600	0:20 - 0:40	-
Convenience food (0.5 kg)	600	6 - 9	2 - 5
Frozen ready meals (0.5 kg)	400	10 - 15	2 - 5
Milk (200 ml)	1000	1 - 1:30	-
Water (200 ml)	1000	1:30 - 2	-
Sauce (200 ml)	600	1 - 3	-
Soup (300 ml)	600	3 - 5	-

Melting

Food	Power (Watts)	Time (min)	Standing time (min)
Chocolate / Chocolate coating (0.15 kg)	300	2 - 4	-
Butter (0.1 kg)	400	0:30-1:30	-

Cooking

Food	Power (Watts)	Time (min)	Standing time (min)
Whole fish (0.5 kg)	500	8 - 10	2 - 5
Fish fillets (0.5 kg)	400	4 - 7	2 - 5
Vegetables, fresh (0.5 kg + 50 ml of water)	600	5 - 15	-
Vegetables, frozen (0.5 kg + 50 ml of water)	600	10 - 20	-
Jacked potatoes (0.5 kg)	600	7 - 10	-
Rice (0.2 kg + 400 ml of water)	600	15 - 18	-
Popcorn	1000	1:30 - 3	-

Microwave Combi function

Use this function to cook food in a shorter time and to brown it.

Combine functions: Grilling and Microwave.

Food	Ovenware	Power (Watts)	Temperature (°C)	Time (min)	Shelf position	Standing time (min)
2 chicken halves (2 x 0.55 kg)	Round glass dish, Ø 26 cm	300	220	40	2	5
Au gratin potatoes (1 kg)	Gratin dish	300	200	40	2	10
Roast pork neck (1.1 kg)	Glass dish with strainer	300	200	70	1	10

13.18 Information for test institutes

Microwave function

Tests according to IEC 60705.

Food	Power (Watts)	Quantity (kg)	Shelf position 1)	Time (min)	Comments
Sponge cake	600	0.475	Bottom	7 - 9	Turn container around by 1/4, halfway through the cooking time.

Food	Power (Watts)	Quantity (kg)	Shelf position 1)	Time (min)	Comments
Meatloaf	400	0.9	2	25 - 32	Turn container around by 1/4, halfway through the cooking time.
Egg custard	300	1	Bottom	18	-
Meat defrosting	100	0.5	Bottom	7 - 8	Turn the meat upside down halfway through the cooking time.

1) Use wire shelf unless otherwise specified.

Combi microwave function
Tests according to IEC 60705.

Food	Function	Power (Watts)	Quantity (kg)	Temperature (°C)	Shelf position 1)	Time (min)	Comments
Cake	True Fan Cooking + MW	100	0.7	180	2	29 - 31	Turn container around by 1/4, halfway through the cooking time.
Potato gratin	Grill + Fan + MW	300	1.1	180	2	40 - 45	Turn container around by 1/4, halfway through the cooking time.
Chicken	Grill + Fan + MW	200	1.1	230	1	45 - 55	Put the meat in round glass container and turn it upside down halfway through the cooking time.

1) Use wire shelf unless otherwise specified.

14. CARE AND CLEANING



WARNING!
Refer to Safety chapters.

14.1 Notes on cleaning

- Clean the front of the oven with a soft cloth with warm water and a cleaning agent.
- To clean metal surfaces, use a dedicated cleaning agent.

- Clean the oven interior after each use. Fat accumulation or other food remains may result in a fire. The risk is higher for the grill pan.
- Clean the cavity roof carefully from food residuals and fat.
- Clean stubborn dirt with a special oven cleaner.
- Clean all accessories after each use and let them dry. Use a soft cloth with warm water and a cleaning agent.
- If you have nonstick accessories, do not clean them using aggressive agents, sharp-edged objects or a dishwasher. It can cause damage to the nonstick coating.
- Dry the oven when the cavity is wet after usage.

14.2 Removing the shelf supports

Before maintenance, make sure that the oven is cool. There is a risk of burns.

To clean the oven, remove the shelf supports.

1. Pull carefully the supports up and out of the front catch.

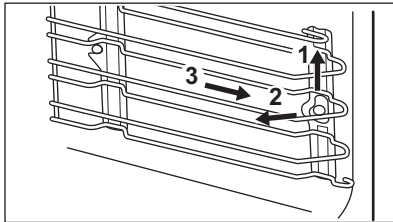

2. Pull the front end of the shelf support away from the side wall.
3. Pull the supports out of the rear catch.

Install the shelf supports in the opposite sequence.

14.3 Replacing the lamp

Put a cloth on the bottom of the interior of the appliance. It prevents damage to the lamp glass cover and the cavity.



WARNING!

Danger of electrocution!

Disconnect the fuse before you replace the lamp.

The lamp and the lamp glass cover can be hot.



CAUTION!

Always hold the halogen lamp with a cloth to prevent grease residue from burning on the lamp.

1. Deactivate the appliance.
2. Remove the fuses from the fuse box or deactivate the circuit breaker.

The top lamp

1. Turn the lamp glass cover counterclockwise to remove it.
2. Clean the glass cover.
3. Replace the lamp with a suitable 300 °C heat-resistant lamp.
4. Install the glass cover.

15. TROUBLESHOOTING





WARNING!

Refer to Safety chapters.

15.1 What to do if...

Problem	Possible cause	Remedy
You cannot activate or operate the oven.	The oven is not connected to an electrical supply or it is connected incorrectly.	Check if the oven is correctly connected to the electrical supply (refer to the connection diagram if available).

Problem	Possible cause	Remedy
The oven does not heat up.	The oven is deactivated.	Activate the oven.
The oven does not heat up.	The clock is not set.	Set the clock.
The oven does not heat up.	The necessary settings are not set.	Make sure that the settings are correct.
The oven does not heat up.	The automatic switch-off is activated.	Refer to "Automatic switch-off".
The oven does not heat up.	The Child Lock is on.	Refer to "Using the Child Lock".
The oven does not heat up.	The door is not closed correctly.	Fully close the door.
The oven does not heat up.	The fuse is blown.	Make sure that the fuse is the cause of the malfunction. If the fuse is blown again and again, contact a qualified electrician.
The lamp does not operate.	The lamp is defective.	Replace the lamp.
The display shows an error code that is not in this table.	There is an electrical fault.	<ul style="list-style-type: none"> Deactivate the oven with the house fuse or the safety switch in the fuse box and activate it again. If the display shows the error code again, contact the Customer Care Department.
Steam and condensation settle on the food and in the cavity of the oven.	You left the dish in the oven for too long.	Do not leave the dishes in the oven for longer than 15 - 20 minutes after the cooking process ends.
The appliance is activated and does not heat up. The fan does not operate. The display shows " Demo ".	The demo mode is activated.	<ol style="list-style-type: none"> Deactivate the appliance. Touch and hold  until the appliance activates and deactivates. Touch and hold  and  at the same time until an acoustic signal sounds. "Demo" goes out.

15.2 Service data

If you cannot find a solution to the problem yourself, contact your dealer or an Authorised Service Centre.

The necessary data for the service centre is on the rating plate. The rating plate is

on the front frame of the appliance cavity. Do not remove the rating plate from the appliance cavity.

We recommend that you write the data here:	
Model (MOD.)
Product number (PNC)
Serial number (S.N.)

16. INSTALLATION



WARNING!
Refer to Safety chapters.

16.1 Building in



The built-in unit must meet the stability requirements of DIN 68930.

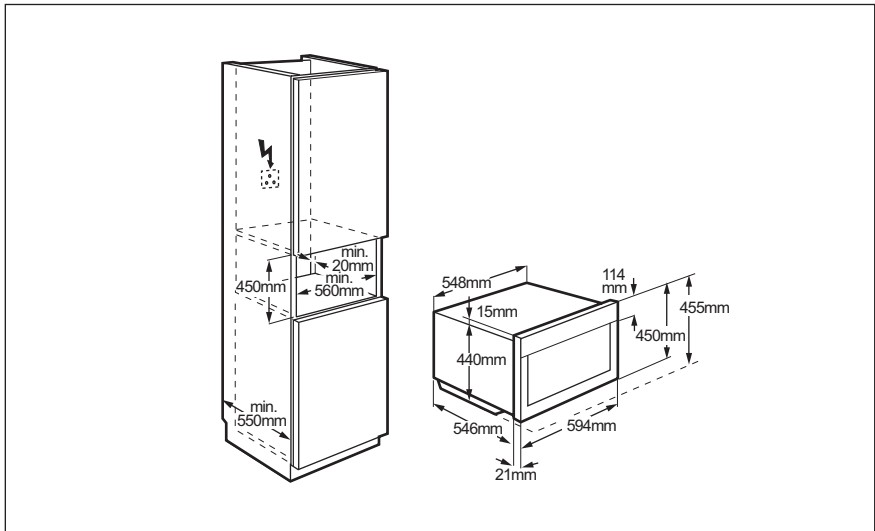

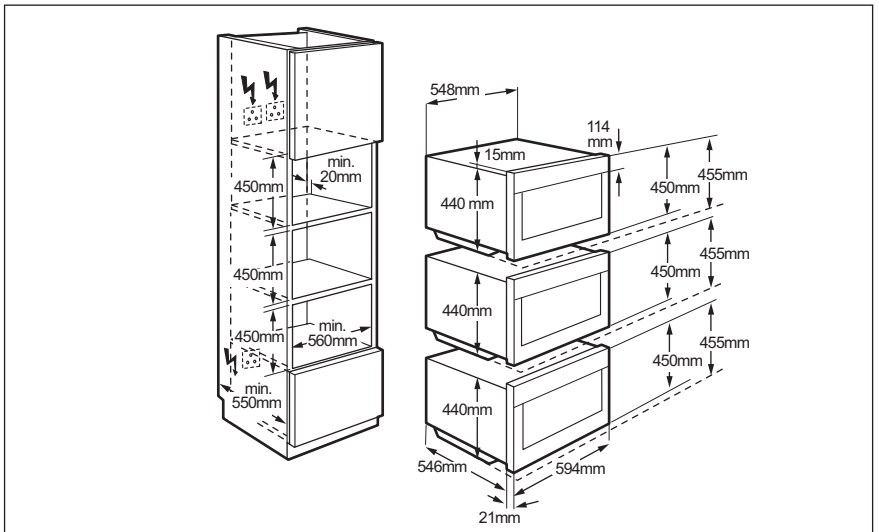
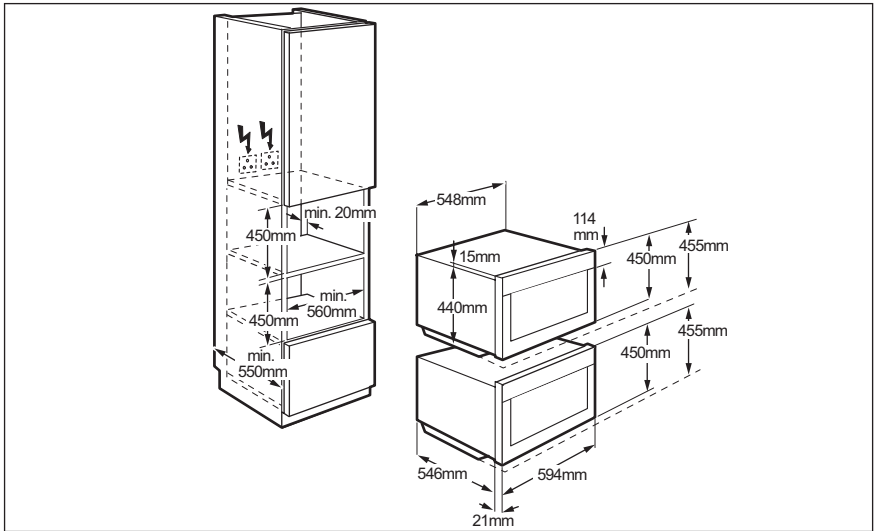

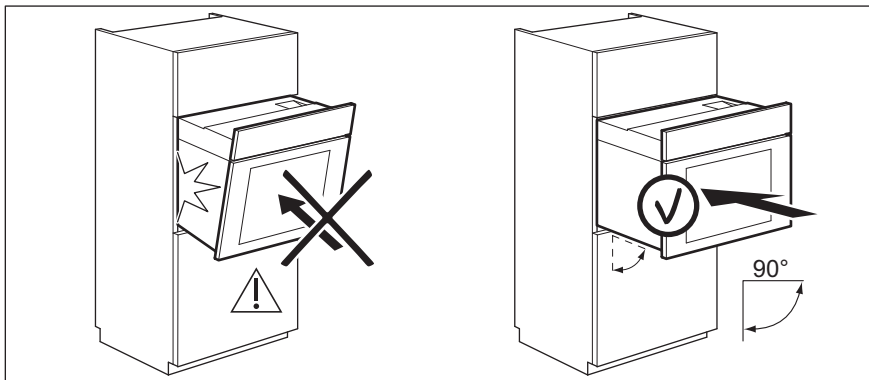
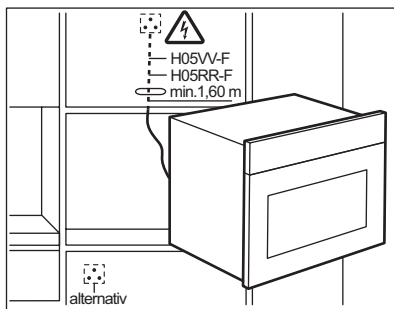
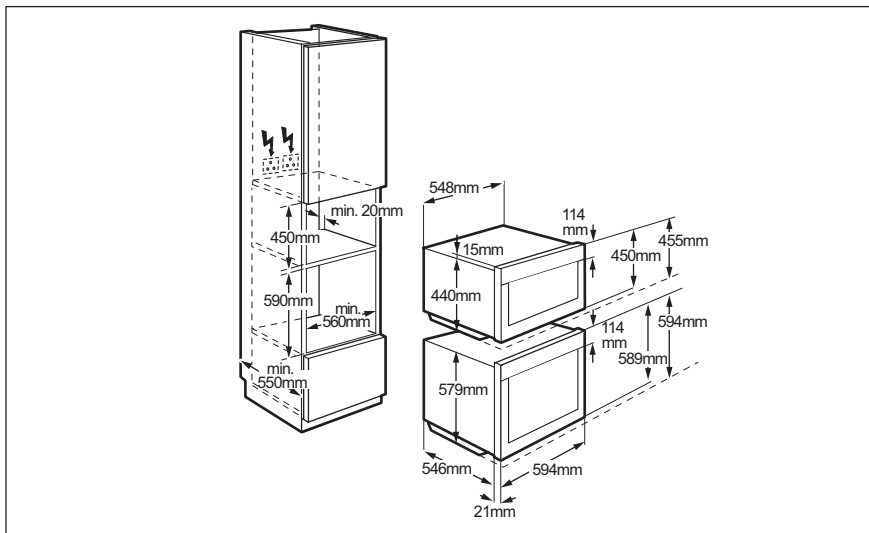

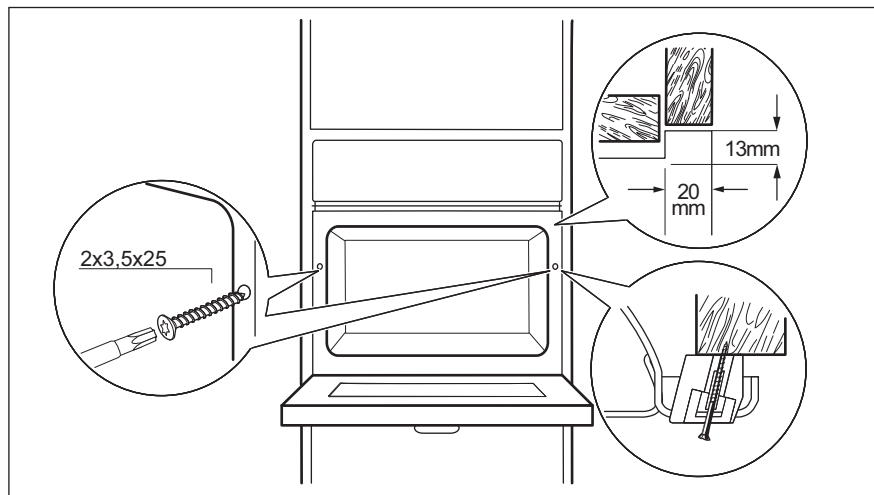

17. ENERGY EFFICIENCY

17.1 Energy saving



The oven contains features which help you save energy during everyday cooking.

General hints

Make sure that the oven door is closed properly when the appliance operates. Do not open the door too often during cooking. Keep the door gasket clean and make sure it is well fixed in its position.

Use metal dishes to improve energy saving, but only when you use a non-microwave function.

When possible, do not preheat the oven before you put the food inside.

When the cooking duration is longer than 30 minutes, reduce the oven temperature to minimum 3 - 10 minutes before the end of the cooking time, depending on the duration of the cooking. The residual heat inside the oven will continue to cook.

Use the residual heat to warm up other dishes.

Keep breaks between baking as short as possible when you prepare few dishes at one time.

Cooking with fan

When possible, use the cooking functions with fan to save energy.

Residual heat

If a programme with the Duration or End Time selection is activated and the cooking time is longer than 30 minutes, the heating elements automatically deactivate earlier in some oven functions.

The fan and lamp continue to operate.

Keep food warm

Choose the lowest possible temperature setting to use residual heat and keep a meal warm. The residual heat indicator or temperature appears on the display.

Cooking with the lamp off

Turn off the lamp during cooking. Turn it on only when you need it.

This document sets out the terms and conditions of the product warranties for AEG Appliances. It is an important document. Please keep it with your proof of purchase documents in a safe place for future reference should there be a manufacturing defect in your Appliance. This warranty is in addition to other rights you may have under the Australian Consumer Law.

1. In this warranty:

- (a) 'ACL' or 'Australian Consumer Law' means Schedule 2 to the Competition and Consumer Act 2010;
- (b) 'Appliance' means any Electrolux product purchased by you and accompanied by this document;
- (c) 'ASC' means Electrolux's authorised serviced centres;
- (d) 'AEG' is the brand controlled by Electrolux Home Products Pty Ltd of 163 O'Riordan Street, Mascot NSW 2020, ABN 51 004 762 341 in respect of Appliances purchased in Australia and Electrolux (NZ) Limited (collectively "Electrolux") of 3-5 Niall Burgess Road, Mount Wellington, in respect of Appliances purchased in New Zealand;
- (e) 'Warranty Period' means the period specified in clause 3 of this warranty;
- (f) 'you' means the purchaser of the Appliance not having purchased the Appliance for re-sale, and 'your' has a corresponding meaning.

2. Application: This warranty only applies to new Appliances, purchased and used in Australia or New Zealand and is in addition to (and does not exclude, restrict, or modify in any way) other rights and remedies under a law to which the Appliances or services relate, including any non-excludable statutory guarantees in Australia and New Zealand.

3. Warranty Period: Subject to these terms and conditions, this warranty continues for in Australia for a period of 60 months and in New Zealand for a period of 60 months, following the date of original purchase of the Appliance.

4. Repair or replace warranty: During the Warranty Period, Electrolux or its ASC will, at no extra charge if your Appliance is readily accessible for service, without special equipment and subject to these terms and conditions, repair or replace any parts which it considers to be defective. Electrolux may, in its absolute discretion, choose whether the remedy offered for a valid warranty claim is repair or replacement. Electrolux or its ASC may use refurbished parts to repair your Appliance. You agree that any replaced Appliances or parts become the property of Electrolux.

5. Travel and transportation costs: Subject to clause 7, Electrolux will bear the reasonable cost of transportation, travel and delivery of the Appliance to and from Electrolux or its ASC. Travel and transportation will be arranged by Electrolux as part of any valid warranty claim.

6. Proof of purchase is required before you can make a claim under this warranty.

7. Exclusions: You may not make a claim under this warranty unless the defect claimed is due to faulty or defective parts or workmanship. This warranty does not cover:

- (a) light globes, batteries, filters or similar perishable parts;
- (b) parts and Appliances not supplied by Electrolux;

- (c) cosmetic damage which does not affect the operation of the Appliance;
- (d) damage to the Appliance caused by:
 - (i) negligence or accident;
 - (ii) misuse or abuse, including failure to properly maintain or service;
 - (iii) improper, negligent or faulty servicing or repair works done by anyone other than an Electrolux authorised repairer or ASC;
 - (iv) normal wear and tear;
 - (v) power surges, electrical storm damage or incorrect power supply;
 - (vi) incomplete or improper installation;
 - (vii) incorrect, improper or inappropriate operation;
 - (viii) insect or vermin infestation;
 - (ix) failure to comply with any additional instructions supplied with the Appliance;

In addition, Electrolux is not liable under this warranty if:

- (a) the Appliance has been, or Electrolux reasonably believes that the Appliance has been, used for purposes other than those for which the Appliance was intended, including where the Appliance has been used for any non-domestic purpose;
- (b) the Appliance is modified without authority from Electrolux in writing;
- (c) the Appliance's serial number or warranty seal has been removed or defaced.

8. How to claim under this warranty: To enquire about claiming under this warranty, please follow these steps:

- (a) carefully check the operating instructions, user manual and the terms of this warranty;
- (b) have the model and serial number of the Appliance available;
- (c) have the proof of purchase (e.g. an invoice) available;
- (d) telephone the numbers shown below.

9. Australia: For Appliances and services provided by Electrolux in Australia: Electrolux goods come with guarantees that cannot be excluded under the Australian Consumer Law. You are entitled to a replacement or refund for a major failure and for compensation for any other reasonably foreseeable loss or damage. You are also entitled to have the Appliance repaired or replaced if the Appliance fails to be of acceptable quality and the failure does not amount to a major failure. 'Acceptable quality' and 'major failure' have the same meaning as referred to in the ACL.

10. New Zealand: For Appliances and services provided by Electrolux in New Zealand, the Appliances come with a guarantee by Electrolux pursuant to the provisions of the Consumer Guarantees Act, the Sale of Goods Act and the Fair Trading Act. Where the Appliance was purchased in New Zealand for commercial purposes the Consumer Guarantee Act does not apply.

11. Confidentiality: You accept that if you make a warranty claim, Electrolux and its agents including ASC may exchange information in relation to you to enable Electrolux to meet its obligations under this warranty.

Important Notice

Before calling for service, please ensure that the steps listed in clause 8 above have been followed.

<p>FOR SERVICE or to find the address of your nearest authorised service centre in Australia PLEASE CALL 1300 363 664 OR EMAIL customercare@aegaustralia.com.au For the cost of a local call (Australia only)</p>	<p>SERVICE AUSTRALIA AEG aeg.com/au</p>	<p>FOR SPARE PARTS or to find the address of your nearest spare parts centre in Australia PLEASE 13 13 50 OR EMAIL customercare@aegaustralia.com.au For the cost of a local call (Australia only)</p>
<p>FOR SERVICE or to find the address of your nearest authorised service centre in New Zealand PLEASE CALL 0800 234 234 OR EMAIL customercare@electrolux.co.nz (New Zealand only)</p>	<p>SERVICE NEW ZEALAND AEG aegnewzealand.co.nz</p>	<p>FOR SPARE PARTS or to find the address of your nearest spare parts centre in New Zealand PLEASE 0800 10 66 20 OR EMAIL customercare@electrolux.co.nz (New Zealand only)</p>

AEG SERVICE AUSTRALIA

www.aeg.com/au

FOR SERVICE

or to find the address of your nearest state service centre in Australia

PLEASE CALL 1300 363 664

OR EMAIL customer care@aegaustralia.com.au

For the cost of a local call (Australia only)

FOR SPARE PARTS

or to find the address of your nearest state spare parts centre in Australia

PLEASE CALL 13 13 50

OR EMAIL customer care@aegaustralia.com.au

For the cost of a local call (Australia only)

AEG SERVICE NEW ZEALAND

www.aeg.co.nz

FOR SERVICE

or to find the address of your nearest authorised service centre in New Zealand

FREE CALL 0800 10 66 10

OR EMAIL customer care@electrolux.co.nz

(New Zealand only)

FOR SPARE PARTS

or to find the address of your nearest state spare parts centre in New Zealand

FREE CALL 0800 10 66 20

OR EMAIL customer care@electrolux.co.nz

(New Zealand only)

19. ENVIRONMENTAL CONCERNS

Recycle materials with the symbol .
Put the packaging in relevant containers to recycle it. Help protect the environment and human health by recycling waste of electrical and electronic appliances. Do not dispose of

appliances marked with the symbol  with the household waste. Return the product to your local recycling facility or contact your municipal office.

www.aeg.com/au

867343213-A-252017



AEG