

**FISHER & PAYKEL**

**ACTIVESMART™  
FREESTANDING REFRIGERATOR**

---

**CONTEMPORARY**

**QUAD DOOR REFRIGERATOR FREEZER ICE & WATER**

RF500QNUB1, RF500QNUX1

**QUAD DOOR REFRIGERATOR FREEZER NON-ICE & WATER**

RF500QNB1, RF500QNX1

**USER GUIDE**

**NZ AU**



## CONTENTS

---

|  |    |
|--|----|
| Safety and warnings  | 4  |
| Before you begin   | 9  |
| Using the control panel  | 10 |
| Storage features   | 11 |
| Using your appliances  | 12 |
| Temperature control  | 12 |
| Door alarms  | 13 |
| Alarm mute   | 13 |
| Key mute   | 13 |
| Key lock   | 13 |
| Sabbath mode   | 14 |
| Features   | 15 |
| Water dispenser*   | 19 |
| Dispenser lock   | 20 |
| Shelves  | 22 |
| Humidity Control Lid   | 22 |
| Wi-Fi connection   | 23 |
| Cleaning and care  | 24 |
| Foodcare   | 30 |
| Moving or storing your appliance   | 32 |
| User warnings and sounds   | 33 |
| Troubleshooting  | 34 |
| Manufacturer's warranty  | 38 |
| European Directive 2012/19/EU on<br>Waste Electrical and Electronic Equipment (WEEE) | 39 |

\*Available in Ice & Water models only.

---

### Registration

To register your product visit our website: [fisherpaykel.com/register](http://fisherpaykel.com/register)

**⚠ WARNING!**



**Electric Shock Hazard**

Failure to do so can result in death, electric shock, fire or injury to persons.

- Read and follow the safety and warnings outlined in this user guide before operating this appliance.

**⚠ WARNING!**



**This appliance contains flammable refrigerant isobutane (R600a).**

## SAFETY AND WARNINGS

---

### READ AND SAVE THIS GUIDE

#### **WARNING!**

Read entire manual. Failure to follow all guides and rules could cause personal injury or property damage. When using this appliance, always exercise basic safety precautions including the following:

#### **General Use**

- This refrigerating appliance is not intended to be used as a built-in appliance.
- This product has been designed for use in a normal domestic (residential) environment.
- Children aged 3 to 8 years may load and unload this appliance under supervision.
- Children should be supervised to ensure that they do not play with the appliance.
- Cleaning and user maintenance shall not be undertaken by children without supervision.
- This appliance can be used by children aged from 8 years and above and persons with reduced physical, sensory or mental capabilities or lack of experience and knowledge if they have been given supervision or instruction concerning use of the appliance in a safe way and understand the hazards involved.
- The manufacturer's installation instructions for product and cabinetry ventilation must be followed when installing the appliance.
- To avoid hazard due to instability of the appliance, it must be fixed in accordance with installation instructions.
- Keep ventilation openings, in the appliance enclosure or the built-in structure, clear of obstruction.
- Do not use mechanical devices or other means to accelerate the defrosting process, other than those recommended by the manufacturer.
- Do not damage the refrigerant circuit.
- In case of damage to the refrigerant circuit, ventilate the area by opening all windows.
- Do not operate electrical equipment or any other equipment that may produce arcs, sparks or flames in the area. Contact your Fisher & Paykel trained and supported service technician immediately to arrange for the appliance to be repaired.
- Connect to potable water supply only.
- This refrigerating appliance is intended to be used at ambient temperatures ranging from 16 °C to 43 °C. The product performance may be compromised when operating outside of this temperature range.
- It is hazardous for anyone other than a Fisher & Paykel trained and supported service technician to service this appliance. In Queensland – the authorized Service Person MUST hold a Gas Work Authorisation for hydrocarbon refrigerants, to carry out Servicing or repairs which involve the removal of covers.

#### **Electrical**

- This appliance must be installed in accordance with the installation instructions before use.
- To allow disconnection of the appliance from the supply after installation, incorporate a switch in the fixed wiring in accordance with the wiring rules.
- Never unplug your refrigerator by pulling on the power cord. Always grip the plug firmly and pull straight out from the outlet.
- Do not plug in any other appliance at the same power point as your refrigerator or use extension cords or double adapters.

## SAFETY AND WARNINGS

---

- Repair or replace immediately all electric service cords that have become frayed or otherwise damaged. Do not use a cord that shows cracks or abrasion along its length or at either the plug or appliance end.
- If the power supply cord is damaged, it must only be replaced by your Fisher & Paykel trained and supported service technician because special purpose tools are required.
- When moving your appliance away from the wall, be careful not to roll over or damage the power cord.
- **WARNING:** Do not use electrical appliances inside the food storage compartments of the appliance, unless they are of the type recommended by the manufacturer.
- When positioning the appliance, ensure the power cord is not trapped or damaged.
- Do not locate multiple portable socket-outlets or portable power supplies at the rear of the appliance.

### Food safety

- Regularly clean accessible draining systems and surfaces that come in contact with food.
- Ensure any raw meat or fish is stored in sealed containers to prevent cross-contamination.
- Immediately clean any drips or spills on surfaces.
- If the appliance will be left empty for long periods, switch off, defrost, clean, dry, and leave the door open to prevent mould developing within the appliance.
- Opening the door for long periods can cause a significant increase of the temperature in the compartments of the appliance.

### Storing food and drinks/wine

- Do not store explosive substances such as aerosol cans with a flammable propellant in this appliance.
- Never store volatile or flammable materials in your appliance as they may explode.
- Never freeze liquids in glass containers. Liquid expands during freezing, which may cause the container to explode.
- Never freeze carbonated drinks. They may explode.

### Servicing

- Your refrigerator is designed to operate for many years without the need for service checks. However, if your refrigerator is malfunctioning, have it attended to by your Fisher & Paykel trained and supported service technician as soon as possible. All electrical repairs must be carried out by an adequately trained service technician or qualified electrician.
- The LED light cannot be serviced by the user. Contact your Fisher & Paykel Dealer or Fisher & Paykel trained and supported service technician.
- If you suspect that the product is not getting cold—items such as ice cream are melting—remove all perishable food and store in another appliance or cooler to prevent spoilage. Immediately call for a service technician.

### Cleaning

- Use mild dish-washing liquid with warm water and a lint-free cloth to clean the product.
- Avoid using anti-bacterial cleaning products on either the interior or exterior of the cabinet as they may cause rusting of metal components and cracking of plastic components.

## SAFETY AND WARNINGS

---

### Disposal

- Extreme care must be taken when disposing of your old appliance to avoid hazards:
- The flammable refrigerant gas must be safely removed by a qualified service technician.
- The thermal insulation foam in this appliance may contain flammable insulation blowing gases, any exposed foam may be highly flammable and must be carefully treated during disposal.
- **WARNING:** Risk of child entrapment. Before you throw away your old refrigerator or freezer, the doors and panels should be removed and the racks left in place so that children may not easily climb inside.
- Consult your local energy authority or local codes as to the best way to dispose of your old appliance.

### Water connection

- The water connection to your Ice & water refrigerator must be installed by an authorised plumber or Fisher & Paykel trained and supported service technician.
- Installation and use **MUST** comply with all state and local plumbing codes. Check with your local public works department for plumbing codes. You must follow their guidelines as you install the water filtration system.
- If the water tank has not been used for an extended period of time, or has developed an unpleasant taste or odour, flush the water system. If the problem persists, replace the water filter cartridge and refer to the flushing instructions detailed in section 'Flushing through the water dispenser'.
- To avoid serious illness or death, only connect your water filter to safe drinking water.
- The water filter cartridge needs to be changed when the replacement indicator icon illuminates. This will happen every six months.
- If the water filtration system has been allowed to freeze, replace filter cartridge. Failure to replace the disposable filter at recommended intervals may lead to reduced filter performance and failure of the filter, causing property damage from water leakage or flooding.
- In cases of excessively reduced filter life — we recommend that you consult a local plumber or your water supplier for advice on suitable filtration requirements for the water supplied to your home.
- Filter replacement is the consumer's responsibility and will not be covered by the warranty except in the case of faulty parts or materials within the filter cartridge.
- If the product has not created ice for some time or ice has an unpleasant taste or odour dispose of ice and refer to 'Automatic ice' for flushing instructions. If unpleasant taste or odour persists, you may wish to fit a new filter cartridge.
- Use new tubing supplied with the refrigerator. **DO NOT** reuse old tubing from old water and ice connections.
- Your water filtration system can withstand up to 827kPa of water pressure.
- **DO NOT** install if water pressure exceeds 827kPa.

### To reduce the risk associated with property damage due to water leakage or flooding:

- **DO NOT** install systems in areas where ambient temperatures may go above 38°C or drop below 0°C.
- **DO NOT** install on hot water supply lines. The maximum operating water temperature of this filter system is 38°C.
- **DO NOT** install where water hammer conditions may occur. If water hammer conditions exist, you must install a water hammer arrester.

## SAFETY AND WARNINGS

---

### **WARNING!**

To reduce the risk associated with choking:

- DO NOT allow children under 3 years of age to have access to small parts during the installation of the water filter.

### **Ice making**

- Avoid contact with the moving parts of the ice maker ejector mechanism, and do not place your fingers on the automatic ice-making mechanism while the appliance is in operation.
- At first use or after water filter has been replaced, there may be discolouration in the first bin of ice cubes. Discard the discoloured ice cubes. If discolouration continues in successive bins, contact your Fisher & Paykel trained and supported service technician.

### **Power failure**

- In the event of a power interruption, the appliance will automatically save the current temperature settings. When power is recovered, the appliance will revert to the current temperature settings only.
- Most power failures are corrected within a short period of time. 1 - 2 hours loss of power will not affect the appliance's temperatures.
- To avoid sudden change of temperature while the power is off, you should avoid opening the door. A refrigerator will keep food safe for up to 4 hours during a power outage. Keep the door closed as much as possible. Discard refrigerated perishable food such as meat, poultry, fish, eggs, and leftovers after 4 hours without power.

### **Light source information**

- This product contains light sources of energy efficiency class F. The light source used in this appliance is not suitable for room illumination.



## BEFORE YOU BEGIN

- Ensure the installer has completed the final checklist in the installation guide.
- Read this guide, taking special note of the safety and warnings section.
- Remove all packaging and dispose of it responsibly. Recycle items that you can.

### Refrigerator compartment

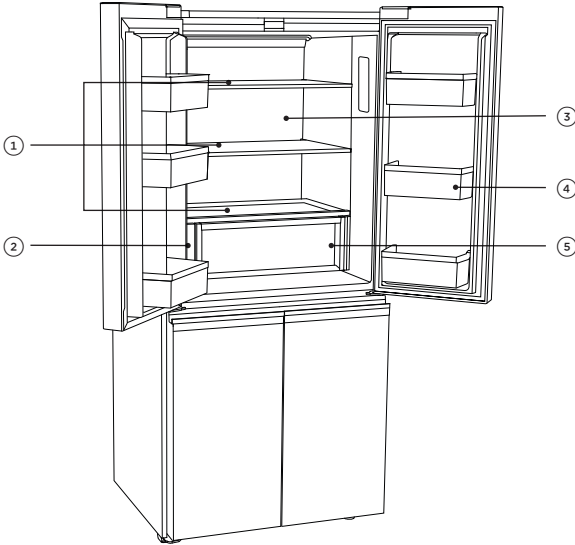

---

#### Refrigerator features

---

- ① Shelving
- ② Water filter\*
- ③ Back light panel
- ④ Door shelves
- ⑤ Humidity control compartment

### Freezer compartment

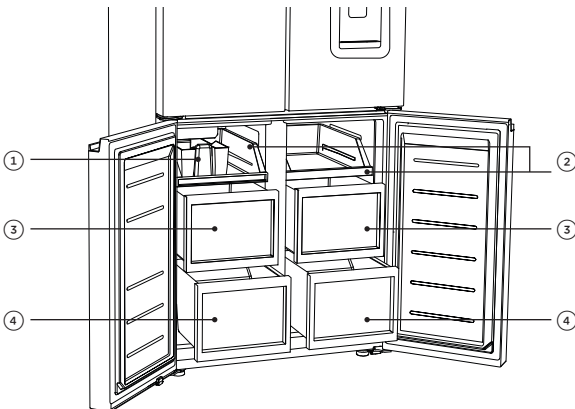

---

#### Freezer features

---

- ① Ice storage bin with scoop\*
- ② Trays
- ③ Mid bins
- ④ Bottom bins

\*Ice & Water models only

## USING THE CONTROL PANEL

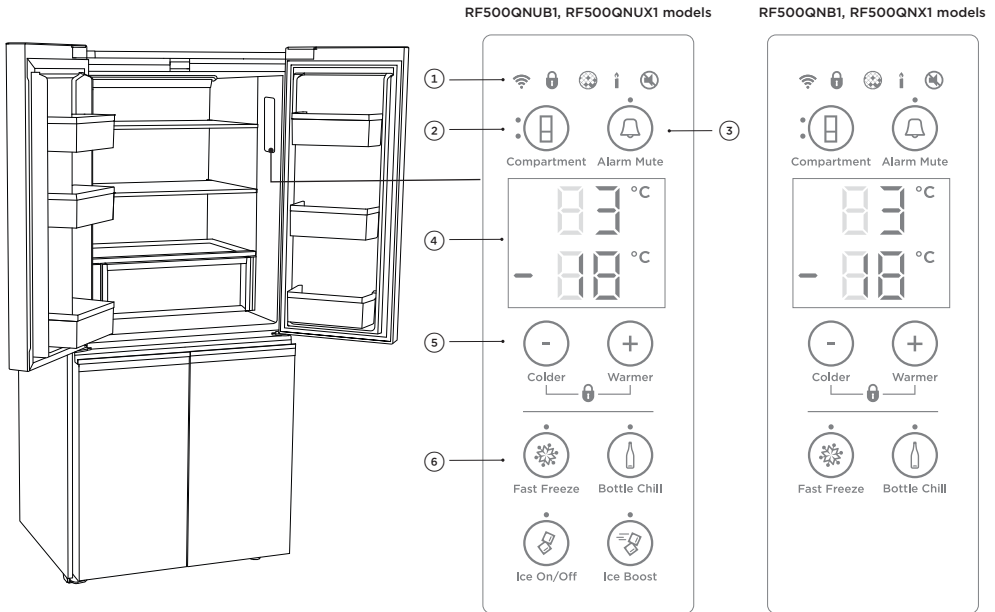

- ① Wi-Fi illuminates when functionality is activated.
- Illuminates to indicate that the keys on the control panel are locked. When the door is closed the display is automatically locked.
- Illuminates when the water filter needs replacing.
- Illuminates to indicate that Sabbath mode is activated.
- Illuminates to indicate key press sounds are deactivated.

- ② Allows you to select the compartment to adjust the temperature.
- Upper light to indicate the refrigerator compartment is selected.
  - Lower light to indicate the freezer compartment is selected.

- ③ Alarm mute deactivates the door alarm for 20 minutes.

- ④ Displays the set temperature of the compartments.
- To change between Celsius and Fahrenheit on the display:  
Press **+** for six seconds.

- ⑤ Allows you to adjust the temperature of the selected compartment.

- ⑥ Allows you to select features:

**FAST FREEZE**

**BOTTLE CHILL**

**ICE ON/OFF**

**ICE BOOST**

## STORAGE FEATURES

---

### REFRIGERATOR

---

|                              |   |
|------------------------------|---|
| Humidity control compartment | Lids create a humid microclimate by reducing dry air going into the bins. The specially designed grooves retain condensation, keeping humidity high and reduce dripping onto the produce below.               |
| Cantilever glass shelving    | Heat-treated safety glass<br>Can be removed and positioned at heights to suit your storage requirements.  |
| Door shelves                 | The door shelves are designed for general items such as condiments and drinks or items you require frequent access to.<br>Clear windows give ultimate visibility to what is being stored in the door shelves. |

---

### FREEZER

---

|              |   |
|--------------|---|
| Ice maker*   | Removable ice container.<br>Hygienic ice scoop. |
| Freezer bins | Allow for easy storage of frozen food items.    |

---

\* Ice & Water and Automatic Ice models only.

## USING YOUR APPLIANCES



### Temperature control



When you turn your refrigerator on for the first time, the cooling system will automatically cool all compartments to their set temperatures within 2-3 hours.

The internal control panel enables you to change and control the temperature of all compartments accurately and independently. The internal control panel default setting is to show the set temperature for the refrigerator compartment.



For common foodstuffs, the factory default setting provides the optimum setting for foodcare.

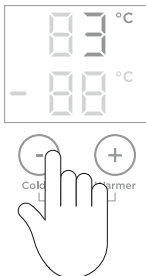

### How to adjust the temperature – Refrigerator compartment

①  Press  until the refrigerator compartment light is illuminated, indicated by the top light.

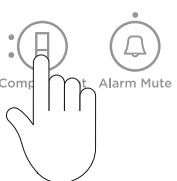
②  Press  to increase the temperature, Press  to decrease the temperature.

### How to adjust the temperature – Freezer compartment

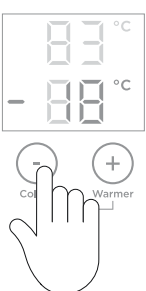
①  Press  twice to adjust the freezer compartment temperature. The freezer compartment light will illuminate.

②  Press  to increase the temperature, Press  to decrease the temperature.



## USING YOUR APPLIANCE

### Door alarms

If the refrigerator compartment door is left open, the alarm will beep after 90 seconds, if the freezer door is left open the alarm will beep after 60 seconds. If either of the doors remains open, subsequent beeps will sound every 30 seconds for five minutes.

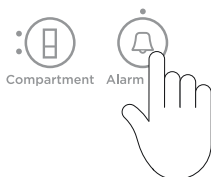
### Alarm mute





To activate/deactivate **ALARM MUTE**, press  once. The light above the  button will illuminate to indicate the door alarm is muted.

**ALARM MUTE** will automatically deactivate after 20 minutes or when the door is closed.

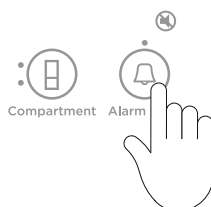
### Key mute



To activate/deactivate **KEY MUTE**, press  for four seconds.

Once **KEY MUTE** is activated the  icon on the internal control panel illuminates, all key sounds are silenced.

Door alarms and the **BOTTLE CHILL** alarm are still operational.

### Key lock

**KEY LOCK** allows you to disable the buttons on the internal control panel. This is useful when cleaning your refrigerator.

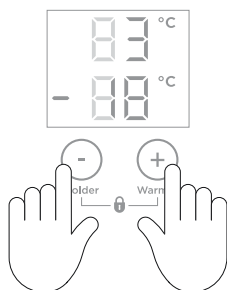

To activate/deactivate **KEY LOCK**, press **-** and **+** together for four seconds.

When **KEY LOCK** is activated the  icon on the internal control panel will illuminate. Pressing any of the buttons will sound several beeps to tell you that they are disabled.

## USING YOUR APPLIANCE



### Sabbath mode

In **SABBATH MODE**, alarms, lights and displays are deactivated for 80 hours.

#### Once in Sabbath mode:

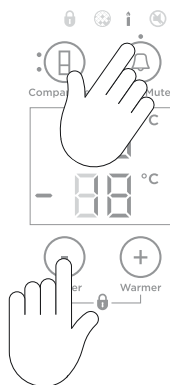
- The interior light will not turn on when you open the refrigerator.
- The door alarms will not operate.
- The display will not illuminate, except the Sabbath mode icon.
- The internal and external control panels will not operate.
- Sabbath mode automatically deactivates after 80 hours.



To activate/deactivate **SABBATH MODE**, press ,  and  together for four seconds.

The  icon on the internal control panel will illuminate when **SABBATH MODE** is activated.

If you turn off your refrigerator while in **SABBATH MODE** it will resume automatically once the refrigerator is switched on again.

## USING YOUR APPLIANCE

---

### Features

#### Fast Freeze

**FAST FREEZE** boosts freezing speed by dropping to its coldest temperature for 12 hours, helping retain freshness, texture and taste during the freezing process.

1



To activate, press  on the internal display. The **FAST FREEZE** light will illuminate.

2



To deactivate before the 12 hours has elapsed, press  again. When **FAST FREEZE** is deactivated the light is off.



For best results activate the function before it is required. Alternatively, activate it when placing food into the freezer.

## USING YOUR APPLIANCE

### Bottle Chill

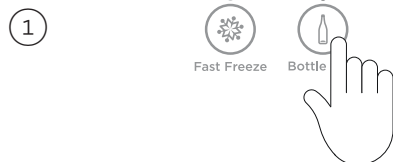
**BOTTLE CHILL** rapidly chills your beverages in the freezer for a set time of 15 minutes. Depending on bottle size, you may need to return it to the freezer and reset.



To activate, press  on the control panel. The **BOTTLE CHILL** light will illuminate. The  icon will illuminate on the external display (Ice & Water models only).

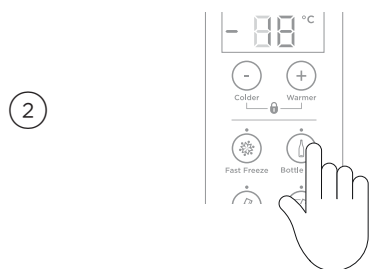



An alarm will sound after 15 minutes to remind you to remove your beverage.

#### **For non water-dispensing models**

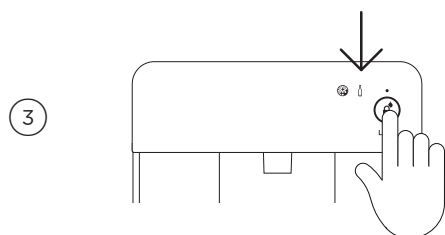
Open the refrigerator compartment door and press any button on the control panel to silence the alarm.



#### **For water-dispensing models**

The  icon will flash on the external display. Press  on the external display to silence the alarm.

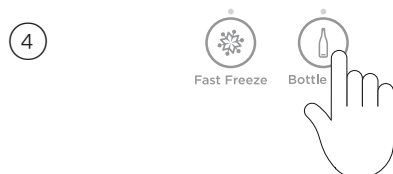

To deactivate **BOTTLE CHILL** before 15 minutes, press the  button on the control panel.

When **BOTTLE CHILL** is deactivated, the light will not illuminate and the icon is not visible on the external display (Ice & Water model only).



## USING YOUR APPLIANCE

### Ice On/Off

**ICE ON/OFF** activates automatic ice - this is only available in the freezer compartment.

Your ice maker is designed to automatically dispense ice into the ice storage bin below until it detects the bin is full. The more ice you use, the more it makes. Before first use the automatic ice systems needs to be flushed. Refer to 'Flushing the water filter' for details.

1

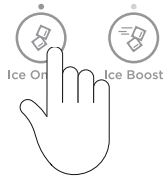

To activate/deactivate, press .

When the ice maker is activated the light will illuminate.



### Ice Boost

**ICE BOOST** increases ice production and will automatically deactivate after 24 hours.

1



When you first turn your ice maker on, **ICE BOOST** is off.

To activate, press . The light above the  button will illuminate.

**ICE BOOST** will pause once your ice bin is full.

2



To manually deactivate press  again. The light will not illuminate.

Activating **ICE BOOST** will automatically turn on ice making.

Deactivating ice making automatically deactivates **ICE BOOST**.

## USING YOUR APPLIANCE

---

### Information about your ice maker

Your automatic ice maker will produce approximately eight cubes of ice every 3-4 hours, depending on the freezer compartment temperature and the number of door openings.

The ice cube tray will fill with water. When cubes are frozen, they will be ejected from the ice tray into the ice storage bin. Ice making will continue until the storage bin is full. Ice making will resume once you start to use the stored ice.

Your Ice & Water product comes with a smaller ice bin inside the freezer tray. Attached to the ice storage bin is the scoop for the ice. This scoop provides hygienic access to the ice. For maximum ice storage, level the stored cubes with the ice scoop.

If ice is not used often, old cubes will become cloudy, taste stale, will shrink and may stick together. Empty the ice storage bin periodically and wash in lukewarm water. Dry thoroughly and place back into the correct position.

### Turn your ice maker off if:

- There is no water supply for several hours.
- You are removing the ice storage bin for a period of time.
- You are going on holiday/vacation.

## USING YOUR APPLIANCE

### Water dispenser\*

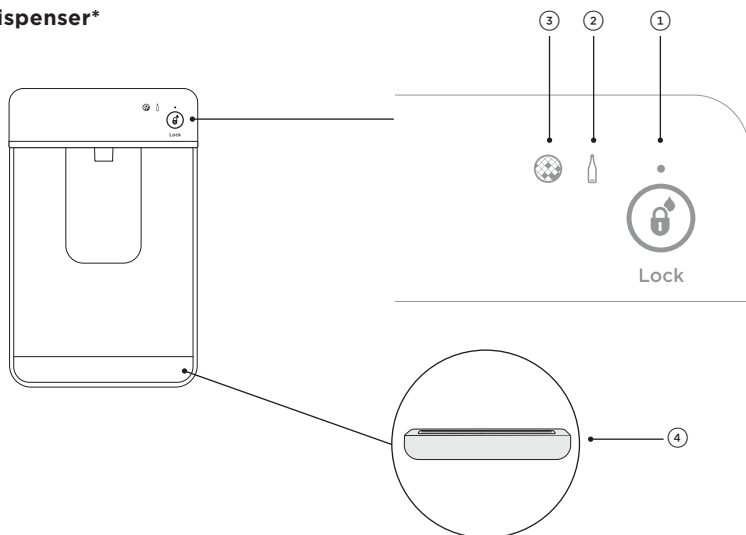

- |  |   |
|--|---|
| ① <b>Dispenser lock button and LED light</b> | Locks/unlocks the water dispenser. The LED above the lock button will illuminate when dispenser is locked.                                      |
| ② <b>Bottle Chill indicator</b>              | Icon will illuminate when <b>BOTTLE CHILL</b> is activated and flashes when the beverage is ready.  |
| ③ <b>Filter change indicator</b>             | Icon will illuminate when water filter requires changing.   |
| ④ <b>Drip tray</b>                           | The drip tray is designed to fit into the bottom of the water dispenser panel to capture any odd drips of water that may fall after dispensing. |

### Using your water dispenser

Ensure you have followed the steps outlined in your installation guide prior to your first use of the water dispenser.

### Dispensing

Your water dispenser is designed for one-handed operation.

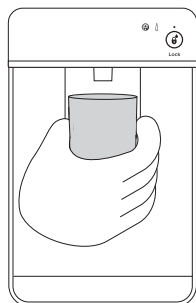

To dispense water, gently press the dispensing pad with a glass or container.

To stop the flow of water, simply pull your glass or container away from the dispensing pad.

Pressing hard against the dispensing pad will not increase the flow or dispense more water.

When dispensing for long durations, a time out period may occur where an alarm will sound. Please wait 3 minutes before dispensing again.

\*Available in Ice & Water models only.

## USING YOUR APPLIANCE

### **Dispenser lock**

The **DISPENSER LOCK** is located on the external display and can be activated to prevent water from being dispensed. This is useful when you are cleaning the external display or when there are small children around.

1



To activate/deactivate **DISPENSER LOCK**, press  for four seconds.

When activated the light above the button will illuminate.

When the dispenser pad is pressed, several beeps will sound to alert the user that water cannot be dispensed.

### **Water filter**

The water supplied to your refrigerator is filtered to remove impurities through a filter located internally at the bottom left corner of the refrigerator. Replace your filter cartridge every 6 months.

- There is a replacement indicator icon  on the internal control panel and external display which will appear when the filter needs replacing. The icon will flash, as a reminder, when water is dispensed.
- Replacement filter cartridges are available from your Fisher & Paykel dealer, online or from a Fisher & Paykel service technician. The details of the replacement filter cartridge are labelled on the cartridge.

### **Changing the water filter cartridge**

Guidance of how to replace your water filter can be found at [fisherpaykel.com/water-filter](https://fisherpaykel.com/water-filter).

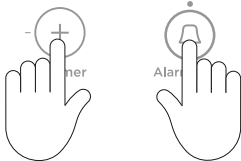

**To reset the  filter indicator:**

Press  and **+** together for 4 seconds.

The  on the control panel will turn off when reset.

## USING YOUR APPLIANCE

### Flushing the water filter

Before you start using the Ice & Water function, complete the flushing steps to ensure optimum performance of your water filter.

### To flush through the water dispenser

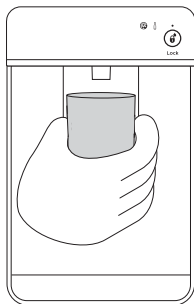

Press the water dispenser pad to dispense 1L of water.



Wait for 3 minutes before dispensing again.

Repeat this cycle 8 times. At least 8L of water needs to be flushed through the system. This prevents excessive dripping of water from your dispenser.

NOTE: There may be carbon residue dispensed together with water. This is not harmful, and normal during flushing process.

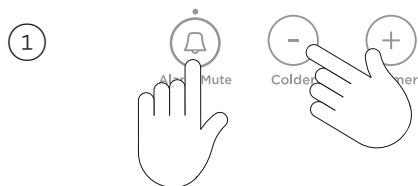
### To flush the automatic icemaker



Press and hold  ,  and  together for 4 seconds then close the door(s). The ice tray will flip twice and empty the water into the bin below. The ice tray will flip only after the doors are closed.

Repeat the cycle to help remove any dust in the ice tray collected during manufacture and transport.

Empty the water in the bin and return the bin correctly. Ensure that the scoop is located in front of the bin.

Once your ice maker is turned on, discard the first 3 harvests of ice (8 cubes per harvest). This will flush away any impurities in the water line and ensure the best ice quality.

Carry out the above steps after a holiday/vacation or extended periods of not using ice.

## USING YOUR APPLIANCE

---

### Shelves

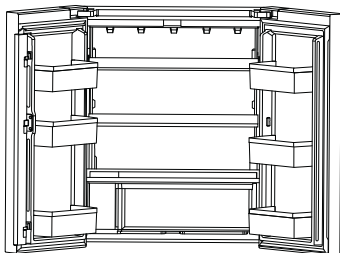

The two full-width cantilever glass shelves are removable and can be repositioned in your refrigerator. The fixed glass shelf can be removed, but not repositioned.

Refer to 'Cleaning and care' for details on how to remove glass shelves.

### Humidity Control Lid

The Humidity Control Lid is fitted to the fruit and vegetable bin of your refrigerator and provides a humid microclimate to extend the storage times of fruit and vegetables. This lid has specially designed grooves that retain moisture to prevent condensation from dripping onto the fruit and vegetables at times of high humidity.

## WI-FI CONNECTION

---

Your appliance may be connected to your home wireless network and operated remotely using the app.

### Getting started

- Ensure your home Wi-Fi network is turned on.
- You will be given step by step guidance on your mobile device.
- It may take up to 10 minutes to connect your appliance.

### On your mobile device:

- ① Download the app from [www.fisherpaykel.com/connect](http://www.fisherpaykel.com/connect)
- ② Register and create an account.
- ③ Add your appliance and set up the Wi-Fi connection.

## CLEANING AND CARE

### Exterior

Clean all surfaces with liquid dishwashing detergent dissolved in warm water and a soft cloth. Rinse with clean water and dry with a clean, lint-free cloth.

Do not use any abrasive stainless steel cleaners, glass cleaners, solvents or scourer pads as these will damage the door surface.

### Door gasket

Clean the magnetic door gasket every three months with a toothbrush, and liquid detergent dissolved in warm water.

### Cabinet surround

To maximise operating efficiency regularly vacuum the flooring around your refrigerator. Cleaning behind your refrigerator is required once or twice a year.

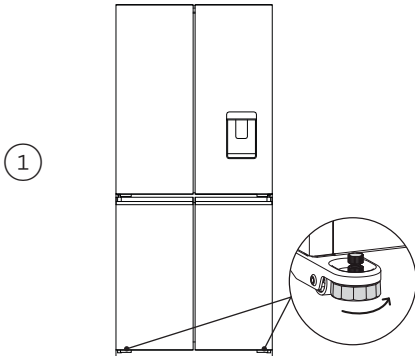

Wind up the feet and carefully ease the refrigerator out of its position. Switch off and unplug.

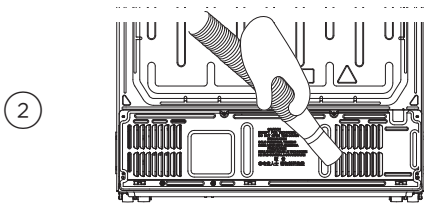

Vacuum the flooring behind your refrigerator and the rear compartment cover (where fitted) to remove dust.

Use a dry lint-free cloth to clean the refrigerator walls and surrounding cabinetry. After cleaning, plug in and switch on. Push the refrigerator into position and wind feet down.



## CLEANING AND CARE

### External display and water dispenser (Water-dispensing models only)

1



Activate the **DISPENSER LOCK** to prevent water from dispensing when cleaning, refer 'Dispenser lock' section for details.

Clean the pad and external display with a damp, soft lint-free cloth.

### Drip tray (Water-dispensing models only)

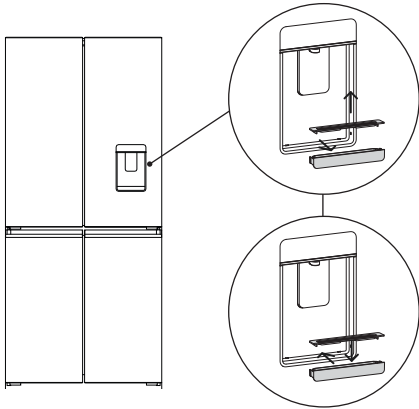

1

Remove the drip tray from the dispenser panel.

Pull the two halves of the tray apart.

Clean with liquid detergent dissolved in water and a soft lint-free cloth.

Rinse with clean water and dry with a clean, lint-free cloth.

2

Securely clip the two halves together.

Re-insert the drip tray back into the dispenser panel, rounded sides first.

### Interior

Do not use harsh chemicals, abrasives, ammonia, chlorine, bleach, concentrated detergents, solvents or abrasive scouring pads on any part of your appliance. Some of these chemicals may damage your appliance.

Clean all surfaces with a mild liquid detergent dissolved in warm water and a soft cloth. Rinse with clean water and dry with a clean, lint-free cloth.

## CLEANING AND CARE

### Glass shelf

#### To remove

①

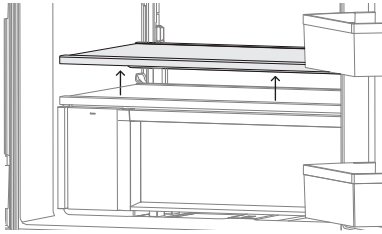

Lift the shelf up vertically. The Humidity Control Lid is attached to the shelf and will be removed together.

②

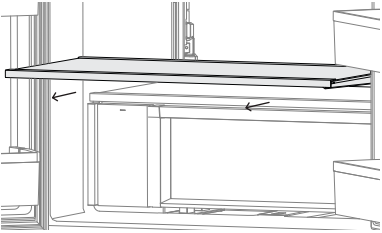

Slide the shelf towards you.  
As you pull the shelf towards you, tilt the front downwards and lower until it is vertical.  
Remove the shelf from the compartment

#### To replace

①

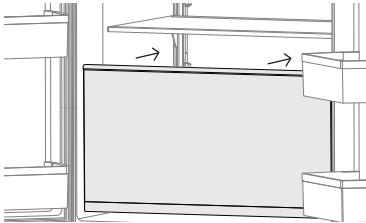

Holding the shelf vertically, slide back into the compartment.

②

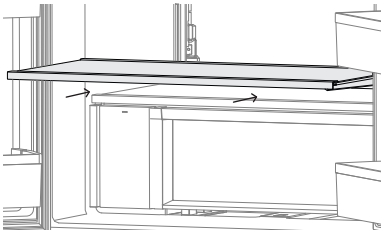

Tilt the shelf back, guide the shelf onto the shelf supports and slide into the compartment.

## CLEANING AND CARE

### Cantilever glass shelves

#### To remove

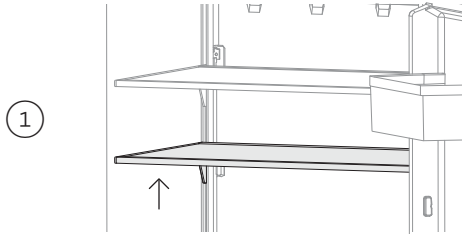

Holding the front and back edge of the shelf firmly, push the shelf up vertically to dislodge from back support lugs.

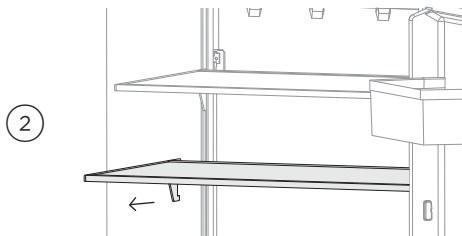

Slide the shelf towards you.

#### To replace

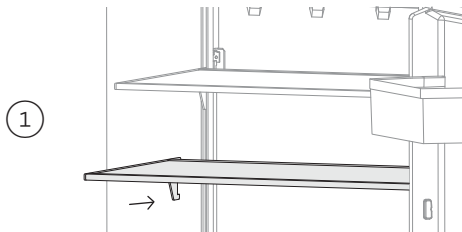

Slide shelf into the compartment.

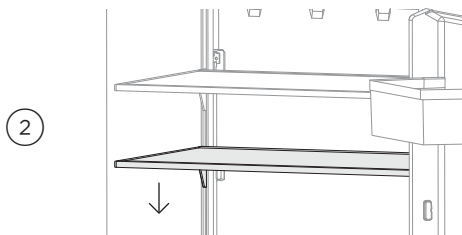

Holding the front and back edge of the shelf firmly, push the shelf down to secure to back support lugs.

## CLEANING AND CARE

### Mid bins and humidity control compartment

To remove

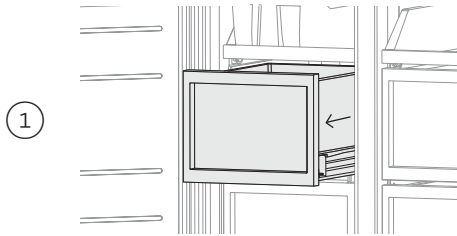

Remove food from the bin.  
Pull the bin out to full extension.

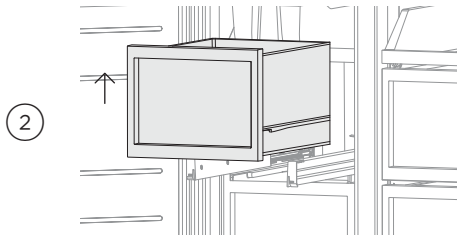

Lift up the bin to dislodge.  
Push the slides back into the compartment.

How to replace

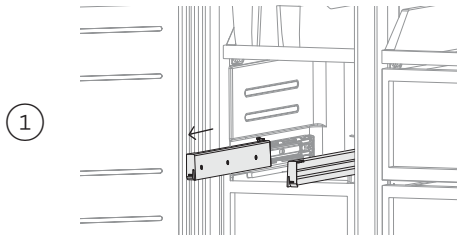

Extend the slide out from the refrigerator.  
Place the bin on top of the runners.

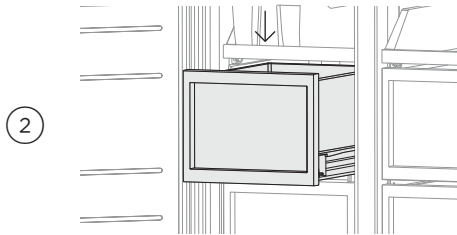

Gently push the bin down on both sides  
at the same time, until you feel it click  
into place.

## CLEANING AND CARE

---

### Bottom bins & trays

To remove

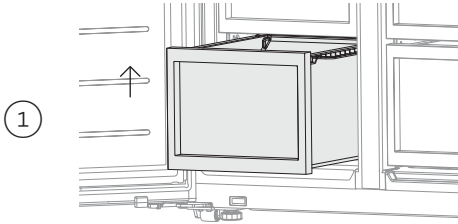

Remove food from the tray or bin.  
Lift the tray/bin up at the front and pull out over the ledge.

How to replace

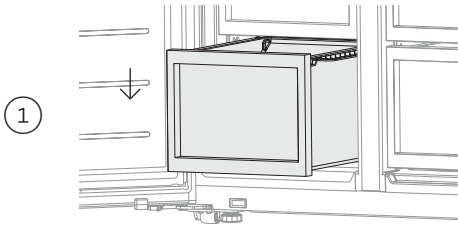

Line up the tray/bin in position and push the bin back over the ledge.

### Ice storage bin

Clean your ice bin and discard any old ice in the bottom of the bin(s) regularly. Ensure that the ice scoop is placed in the centre of the bin.

## For best food care

- Store only high-quality, fresh food in your refrigerator.
- Store perishable foods in the refrigerator immediately after purchase. Storing at room temperature increases the rate of deterioration and can allow harmful microbial growth.
- Foods such as meat, poultry and seafood should be well wrapped or sealed in suitable packaging to prevent dehydration, colour deterioration, loss of flavour, and transfer of odour.
  - We recommend storing these foods on the bottom shelf of your refrigerator to prevent potential spills and cross-contamination with other foods.
- Ensure hot foods and beverages are cooled sufficiently before placing them into the refrigerator. Hot items may cause other foods to warm to unsafe temperatures. Hot items may also cause sealed items to sweat/condensate— which is undesirable.
- Beverages are best stored standing upright in the door shelves or on the bottle racks provided.
- Ensure raw and cooked foods are stored separately to avoid cross-contamination.
- Consume food items within the recommended storage times. Discard foods that show sign of spoilage.
- Keep door openings to a minimum to maintain optimum storage temperatures inside your refrigerator.
- We recommend using **FAST FREEZE** when you are adding food items to your product, such as after grocery shopping. This feature will ensure the food is frozen within the shortest period of time, locking in the freshness and extending the shelf life of your food.
- For storage of general household foods in the most efficient manner, it is recommended to use the product in the factory configuration supplied. Moving the shelves and bins will have a minimal impact on efficiency.
- Storing at temperatures other than settings recommended may impact the storage life.

## Items stored in your refrigerator

- Dairy items such as butter and cheeses should be stored in the door shelf to minimise any transfer of odour or odour absorption from other foods.
- Eggs should be stored in their carton to avoid absorption of strong odours through their porous shell structure.

### Items stored in your freezer

- We recommend cooling carbonated beverages only when the **BOTTLE CHILL** function is active.
  - Do not store carbonated drinks without this function in the freezer. Failure to remove beverages could lead to freezing liquid and the likelihood of bottle/can explosion.
- Ensure air is removed from packaging to avoid large formation of ice crystals and prevent freezer burn.
- To maintain freshness and quality, we recommend defrosting foods in the refrigerator. These foods should not be in contact with fresh foods. Ensure partially or fully defrosted foods are never re-frozen – cook immediately.
- Do not store foods to be frozen in contact with food for storage. If defrosting frozen food in the refrigerator compartment ensure frozen items are not in contact with fresh foods.
- Defrosting food repeatedly is not recommended. Frozen foods that will be used regularly should be stored in smaller quantities.

## MOVING OR STORING YOUR APPLIANCE

If your refrigerator is turned off for any reason, wait 10 minutes before turning it back on. This will allow the refrigeration system pressures to equalise before restarting.

### Moving your refrigerator

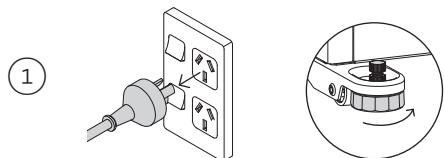

Turn off the refrigerator and unplug from the power point. Remove all food.

Turn the adjustable feet to the right as far as they will turn.

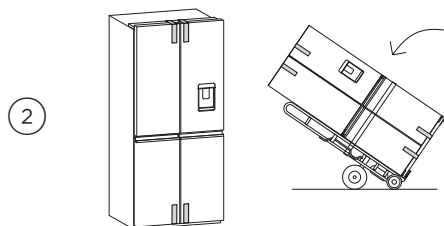

Ease the refrigerator out of its position.

Tuck the power cord away, tape the shelves in place and tape the doors closed. If the cabinet needs to be placed at an angle or laid down, carefully lay it on its side (the left hand side when viewed from the front).

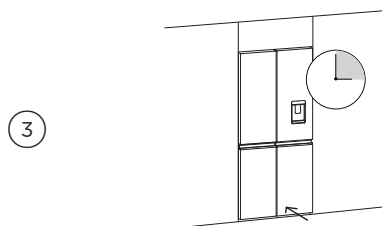

Relocate and install. If the refrigerator has been left on its side for any length of time, leave it standing upright as long as you can (a few hours) before turning on.

Take care when moving this refrigerator, ensure all obstacles are removed to prevent any physical impact that may cause damage.

### Storing your Refrigerator

- When storing your cleaned refrigerator, leave the doors open. This allows air to circulate and prevents the build up of bacteria and moulds.
- Before using again, clean well using a mixture of warm water and a small amount of liquid dishwashing detergent. Rinse with clean water and dry with a soft lint-free cloth.

### Holiday/Vacation time

Leave your refrigerator operating while you are on holiday/vacation.



### Faults

- Count the number of beeps made when the refrigerator compartment door is opened.
- Record the number and sequence of temperature lights displayed on the internal control panel and contact a Fisher & Paykel trained and supported service technician in order to repair the fault. You can do this by going online to [fisherpaykel.com](http://fisherpaykel.com) or by contacting our Customer Care Centre.
- To silence the fault alarm press any button on the **internal** control panel.

### Normal refrigerator sounds

ActiveSmart™ refrigerators are designed to have excellent energy ratings and cooling performance. As a result, you may hear sounds somewhat different to your old refrigerator.

#### Normal operational sounds include:



- **Fan air flow sound.** ActiveSmart™ refrigerators have fans which change speed depending on demand. During cooling periods, such as after frequent door openings, fans circulate the cold air in the refrigerator and freezer compartments producing some air flow sound. This is quite normal.
- **Cracking or popping sounds.** This may occur when the automatic defrost function is operating.
- **Running water sound.** This is the liquid refrigerant in the system and can be heard as a boiling or gurgling noise.
- **An audible hissing sound after closing the freezer door.** This is due to the pressure difference between the warm air that has entered the cabinet and suddenly cooled, and the outside **air pressure**.
- **Humming sounds.** This is the compressor running and is quite normal.
- **Gasket noises.** Normally occur over time due to a build up of dirt and/or grime. See 'Cleaning and care' section.
- **Ice maker and water dispenser sounds:**
  - Motor operation (low humming).
  - Running water as the ice maker and/or water tank fills.
  - Water valve opening and closing (hissing sound).
  - Loosened from the ice molding tray (cracking).
  - Ice dropping into bin (clunking).
- **Other sounds may be heard for the following reasons:**
  - Cabinet not level
  - Floor uneven or weak
  - Bottles or jars rattling on shelves

## TROUBLESHOOTING

If there is a problem with your refrigerator, please check the following points before contacting your local Fisher & Paykel trained and supported service technician or the Customer Care Centre.

Product parts and accessories can be purchased through Fisher & Paykel Customer Care Centre or online at [fisherpaykel.com](http://fisherpaykel.com) (this service is available to selected markets only).

### All models

| PROBLEM                           | POSSIBLE CAUSES                               | WHAT TO DO  |
|-----------------------------------|---|---|
| Refrigerator does not operate     | No electricity at power outlet.               | Check that the plug is correctly connected and power switched on.   |
|                                   |   | Check another refrigerator at the same outlet.  |
|                                   |   | Check house fuse.   |
| Light not working                 | Light not functioning.                        | The LED light cannot be serviced by the user. Contact your Fisher & Paykel Dealer or Fisher & Paykel trained and supported service technician.  |
|                                   | Refrigerator not working.                     | Check refrigerator is turned on at wall.  |
| Light and display not working     | Product in <b>SABBATH MODE</b> .              | Press and hold  ,  and  together for four seconds. |
| Motor operates for long periods   | Hot weather.                                  | Minimise door openings to allow temperature to stabilise.   |
|                                   | Frequent door openings.                       |   |
|                                   | Large amount of food recently added.          |   |
|                                   | Temperature control set too low.              |   |
|                                   | Doors not sealing properly.                   | Check that cabinet is level and gasket seals are clean.   |
| Storage compartments too warm     | Temperature setting not correct.              | Refer to section 'Temperature control'.   |
|                                   | Frequent door openings.                       | Minimise door openings to allow temperature to stabilise.   |
|                                   | Large amount of food recently added.          |   |
| Food freezing in the refrigerator | Temperature setting not correct.              | Refer to section 'Temperature control'.   |
|                                   | Food placed directly in front of air outlets. | Move chill sensitive foods away from the centre back of the shelves.  |

## TROUBLESHOOTING

### All models

| PROBLEM  | POSSIBLE CAUSES   | WHAT TO DO  |
|--|---|---|
| Unfamiliar noises                                | Cabinet not stable or level.<br>Freezer is defrosting.                            | Refer to your Installation guide or 'User warnings and sounds'.   |
| Water in the vegetable bin                       | Condensation is formed by the water produced by fruit and vegetables.             | A small amount of condensation is beneficial for fruit and vegetable storage.<br>Wipe out water with a cloth. |
| Exterior of cabinet is warm                      | This is normal.   |   |
| Condensation on outside of refrigerator/freezer  | Not unusual during periods of high humidity.                                      | Wipe dry.   |
| Condensation inside refrigerator compartment     | Frequent or long door openings.<br>Door gasket leaking.                           | Minimise door openings.<br>Check that gasket is sitting flat and sealing tightly.                             |
|  | Not unusual during periods of high humidity.                                      | Wipe dry.   |
| Door out of alignment                            | With time and usage, movement may occur.  | Refer to your installation guide.   |
| Tray/bin does not slide in and out evenly        | Packaging trapped.  | Check to ensure no food or packaging is trapped behind the tray/bin.  |
|  | Runners not extending fully.  | Holding onto sides of tray/bin, extend the runners fully by using a firm pull – this will reset the runner.   |
| Refrigerator operating inefficiently             | Accumulation of dust on or behind the rear compartment cover.                     | Refer to section 'Cleaning and care'.<br>If problem persists please contact Customer Care.                    |
| Cannot adjust temperature in freezer compartment | Either <b>BOTTLE CHILL</b> , <b>FAST FREEZE</b> or <b>ICE BOOST</b> is activated. | Deactivate <b>BOTTLE CHILL</b> , <b>FAST FREEZE</b> or <b>ICE BOOST</b> if function is not desired.           |

## TROUBLESHOOTING

### Ice & Water models only

| PROBLEM   | POSSIBLE CAUSES   | WHAT TO DO   |
|---|---|--|
| <b>Automatic ice maker does not work</b>  | Ice maker has not been turned on.                             | Switch on ice maker.   |
|   | Bin is in the wrong way or there is no bin in place.          | Place bin so scoop is in the front of the ice bin.<br><br>Ice bin sits directly under ice maker on top left side of freezer. |
|   | Water supply turned off or not connected.                     | Connect water supply.  |
|   | Freezer compartment not working.                              | Contact Customer Care.   |
|   | Water pressure too low.                                       | Check water pressure.  |
|   | Water line kinked/squashed.                                   | Check water line for kinks/squashing.  |
|   | Filter clogged.   | Water filter may need replacing.   |
| <b>Ice cubes have odour/taste</b>   | Unsealed packages may be transmitting odour/taste.            | Old cubes need to be discarded.<br>Ensure food packaging is sealed.  |
|   | Interior of freezer needs cleaning.                           | Ice storage bin needs to be emptied and washed.<br><br>Clean refrigerator.   |
|   | Poor taste from incoming water.                               | Filter may need to be replaced with new one.<br><br>Force 2 - 3 ice tray flips.  |
|   |   |  |
| <b>Slow ice cube freezing</b>   | Door may have been left ajar.                                 | Close door.  |
|   | Freezer compartment too warm.                                 | Turn temperature to a colder setting.  |
| <b>Wet ice/ ice clumping</b>  | Low water pressure.   | Check water pressure.  |
|   | Filter blocked.   | Replace filter.  |
|   | Long freezer door openings.                                   | Gently tap ice with scoop to unstick or, if large clumps occur, empty ice bin and make new ice.                              |
|   | High ambient temperature.                                     |  |
|   | Ice bin left out of freezer compartment for a length of time. |  |
| Ice will stick together over time.  |   |  |
| <b>Filter warning light  is flashing</b> | Filter needs replacing.                                       | Replace filter as soon as possible.  |

## TROUBLESHOOTING

### Ice & Water models only

| PROBLEM  | POSSIBLE CAUSES  | WHAT TO DO  |
|--|--|---|
| Ice build up inside freezer compartment                  | Freezer door not closing tightly.  | Arrange items in freezer so door can close tightly.<br>Check and clean door gasket seal.  |
| Ice maker makes unfamiliar sounds or seems too loud      | Normal ice maker operation.  | Refer to section 'User warnings and sounds'.  |
| Ice boost function not increasing rate of ice production | Ambient temperature very warm.<br>Refrigerator is in high usage.   | Minimise door openings.   |
| Water has poor taste/odour                               | Refrigerator not used for an extended period.<br>New filter installed.   | Dispense 8L of water so fresh water supply is replenished.  |
| Water dispenser does not work                            | Water supply turned off or not connected.<br>Supply line may be blocked.<br>On first installation there may be air in water system.<br>Filter may be blocked and need replacing. | Turn water on.<br>Press dispenser for four minutes to remove trapped air from water line and to fill the water system.<br>Check supply for kinks or leaks.<br>To remove air, run 8L of water through the dispenser.<br>Replace filter (see your 'Service & Warranty' document provided with your refrigerator). |
|  | DISPENSER LOCK activated.  | Press and hold  for four seconds.   |
|  | Water frozen in tank.  | Increase temperature to a warmer setting in refrigerator compartment and freezer.   |
| Water in first glass is warm                             | Water dispenser not used for extended period.<br>Tank capacity used recently.  | Discard first glass of water dispensed.<br>Allow water time to cool.  |
| Drips overflow drip-shelf                                | Air trapped in tank.<br>New filter installed.  | Flush 8L water through dispenser, stopping intermittently.<br>Flush 8L water through dispenser, stopping intermittently.  |
| Water flow rate has slowed down                          | Filter cartridge is restricted.  | Replace filter as soon as possible.   |

## MANUFACTURER'S WARRANTY

---

For details of your Manufacturer's Warranty and contacts for servicing, please refer to your separate 'Service & Warranty' book provided with your refrigerator.

This product has been designed for use in a normal domestic (residential environment). This product is not designed for any commercial use. Any commercial use by the customer will affect this products Manufacturer's Warranty.

For spare parts, please contact Fisher & Paykel Customer Care. Spare parts are available for all Fisher & Paykel refrigerators for a minimum period of 10 years from the date of manufacture.

### Complete and keep for safe reference:

Model \_\_\_\_\_

Serial No. \_\_\_\_\_

Purchase Date \_\_\_\_\_

Purchaser \_\_\_\_\_

Dealer \_\_\_\_\_

Suburb \_\_\_\_\_

Town \_\_\_\_\_

Country \_\_\_\_\_

## EUROPEAN DIRECTIVE 2012/19/EU ON WASTE ELECTRICAL AND ELECTRONIC EQUIPMENT (WEEE)

---

**GB** This appliance is marked according to the European directive 2012/19/EU on Waste Electrical and Electronic Equipment (WEEE). By ensuring this product is disposed of correctly, you will help prevent potential negative consequences for the environment and human health, which could otherwise be caused by inappropriate handling of this product.

The symbol  marked on the serial plate, or on the documents accompanying the product, indicates that this appliance cannot be treated as household waste. It shall be handed over to the applicable collection point for the recycling of electrical and electronic equipment. Disposal of the appliance shall be carried out in accordance with the local environment regulations for waste disposal and ensure the refrigerant circuit is not damaged.

For more detailed information about treatment, recovery and recycling of this product, please contact your local city office, your household waste disposal service or your Fisher & Paykel retailer/dealer from whom you purchased this product.

**FISHERPAYKEL.COM**

© Fisher & Paykel Appliances 2023. All rights reserved.

The models shown in this guide may not be available in all markets  
and are subject to change at any time.

The product specifications in this guide apply to the specific products and  
models described at the date of issue. Under our policy of continuous product  
improvement, these specifications may change at any time.

For current details about model and specification availability in your country,  
please go to our website or contact your local Fisher & Paykel dealer.

**431113B 02.23**