

Oliveri®

Model: SB35CU

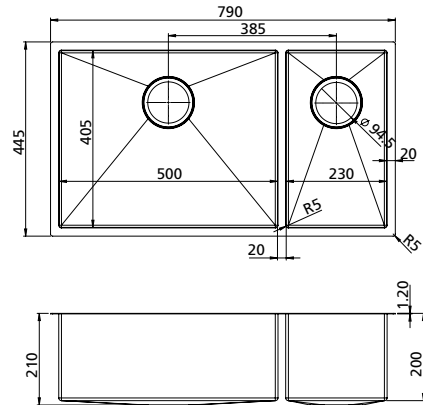

FEATURES

Comfort Curve

A curved bridge acts as a natural overflow and provides extra room to grip under the included chopping board.

Coloured steel

An environmentally friendly process creates the coloured coating on 1.2mm stainless steel.

Rear waste outlets

The matching colour outlets allow maximum space in the cupboards below.

Softtone® and soundproofing

Ensures improved heat retention and a sound deadening finish.

Easy clean corners

Softly squared 5mm radius corners are hygienic and easy to clean.

INCLUDED ACCESSORIES

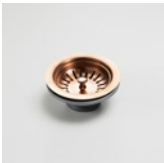

ACBWCU Copper
Basket waste



ACP104F
Bamboo board

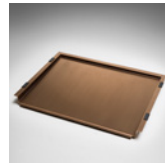

ACP109CU Copper
Bench top drainer tray

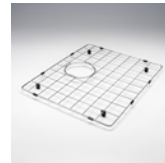

ACBPCU-1 Copper
Bowl protector

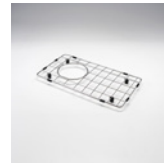

ACBPCU-3 Copper
Bowl protector

MATCHING ACCESSORIES

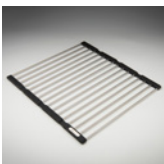

ACP105
Foldamate



ACP136
Colander

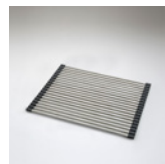

ACP106
Kitchenmate



ACP31
Drainer basket



ACP29
Opti space connector

RECOMMENDED TAPWARE



VT0398B
WELS 4 star
6.5 L per min

PT2010C-BLACK
WELS 4 star
7.5 L per min

SPECIFICATIONS

Description

1 & 1/2 bowl copper sink

Sink Size

790W x 445H

Large Bowl

500W x 405H x 200D / 40L

1/2 Bowl

230W x 405H x 200D / 18L

Construction

Fabricated with 5mm radius corners, Softtone® and soundproofing

Material

304 grade, 18/10 coloured stainless steel (1.2mm thick)

Installation

Topmount, undermount or flushmount

EAN

9324974012113

Fixings

Topmount clips supplied only

Cut out template

oliveri.com.au

Min cabinet size

900mm

Tap holes

N/A

Waste fittings

2 x 90mm coloured basket wastes included

Overflow

Not available

Carton size

880 x 540 x 330 mm

Weight

19.0 kg

Warranty

Lifetime manufacturer's warranty (refer to oliveri.com.au)



For more information call **1300 137 465** or visit **oliveri.com.au**